

Install FreeBSD

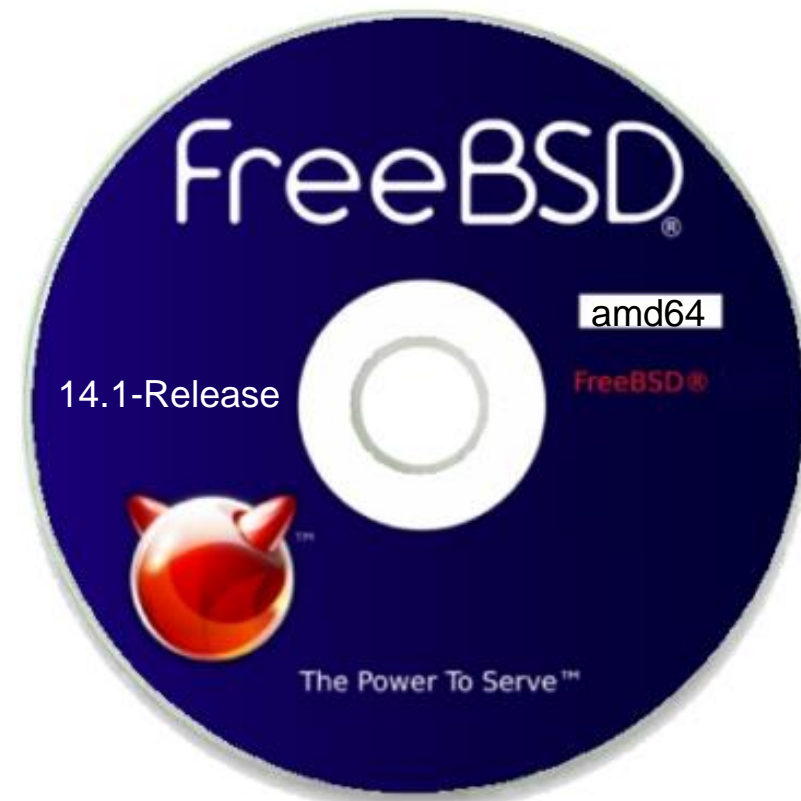

<https://www.ebay.com/itm/386901286067>

tsaimh (2022-2024, CC BY-SA)
lctseng (2019-2021, CC BY-SA)
? (1996-2018)

國立陽明交通大學資工系資訊中心

Information Technology Center, Department of Computer Science, NYCU

Outline

- FreeBSD version
 - 14.1-RELEASE
- Installing FreeBSD
 - From DVD/CD-ROM (iso image)

FreeBSD Version

國立陽明交通大學資工系資訊中心

Information Technology Center, Department of Computer Science, NYCU

FreeBSD Branches/Tags

- Three parallel development branches:
 - RELEASE
 - Suitable for production use
 - Latest Release: 14.1 (June, 2024)
 - <http://www.freebsd.org/releases/>
 - STABLE
 - Tested new features and bug fixes
 - ABI/KBI is "stable"
 - Still considered a development branch
 - CURRENT
 - Working space for FreeBSD developers
 - 15-CURRENT (2024)
 - <http://www.freebsd.org/releng/>

FreeBSD Versions

- FreeBSD–A.B.C–Type
 - A: major version Number
 - B: minor version Number
 - C: slight patch version number
 - Type: version type
 - PRERELEASE, BETA, RC
 - RELEASE
 - STABLE
 - CURRENT
- freebsd-version(1)
- -pN
 - patch level, increased after SA/EN announced

End-of-Life (EoL)

- The last supporting date of given OS version
 - Typically, no guaranteed security update/patch for an OS passed its EoL
- All OS have EoL
 - [FreeBSD 14.0: 14.1-RELEASE + 3 months](#)
 - [Ubuntu 24.04 LTS: 2029-06](#)
 - [CentOS Linux 8: 2021-12-31](#)
 - [Windows 7: 2020-01-14](#)
- If your OS is approaching its EoL, please consider updating it
 - Plan as early as possible
 - Good habit: prepare and evaluate upgrading when new version is out

Branch	Release	Release Date	Expected EoL
stable/14	n/a	n/a	November 30, 2028
releng/14.1	14.1-RELEASE	June 4, 2024	14.2-RELEASE + 3 months
releng/14.0	14.0-RELEASE	November 20, 2023	September 30, 2024
stable/13	n/a	n/a	April 30, 2026
releng/13.3	13.3-RELEASE	March 5, 2024	13.4-RELEASE + 3 months

Support Model

- Use FreeBSD as an example

<https://www.freebsd.org/security/#model>

Under the current support model, each **major version**'s stable branch is explicitly supported for **5 years**, while each individual **point release** is only supported for **three months after the next point release**.

- Common support types
 - Normal (feature and security updates)
 - Security only (maintenance mode)
 - LTS (Long term support, good for services infrastructure)
 - Extended (longer than normal), paid (commercial) support, ...

FreeBSD Installation

國立陽明交通大學資工系資訊中心

Information Technology Center, Department of Computer Science, NYCU

Installation Handbook

- Complete installation guide and be found at
 - <https://www.freebsd.org/doc/handbook/bsdinstall.html>
 - https://www.freebsd.org/doc/zh_TW/books/handbook/bsdinstall.html

View of Disk (1)

ada0p1: GPT
ada0s1: MBR

- Guided partitioning layout (GPT) between UFS and Root on ZFS

GPT (UFS)	
Partition 1 (/dev/ada0p1)	freebsd-boot
Partition 2 (/dev/ada0p2)	freebsd-ufs
Partition 3 (/dev/ada0p3)	freebsd-swap

GPT (ZFS on Root)	
Partition 1 (/dev/ada0p1)	freebsd-boot
Partition 2 (/dev/ada0p2)	freebsd-swap
Partition 3 (/dev/ada0p3)	freebsd-zfs

ada: SATA or IDE hard disk
da: SCSI or USB
nvd or nda: NVMe
cd: CD-ROM

View of Disk (2)

ada0p1: GPT
ada0s1: MBR

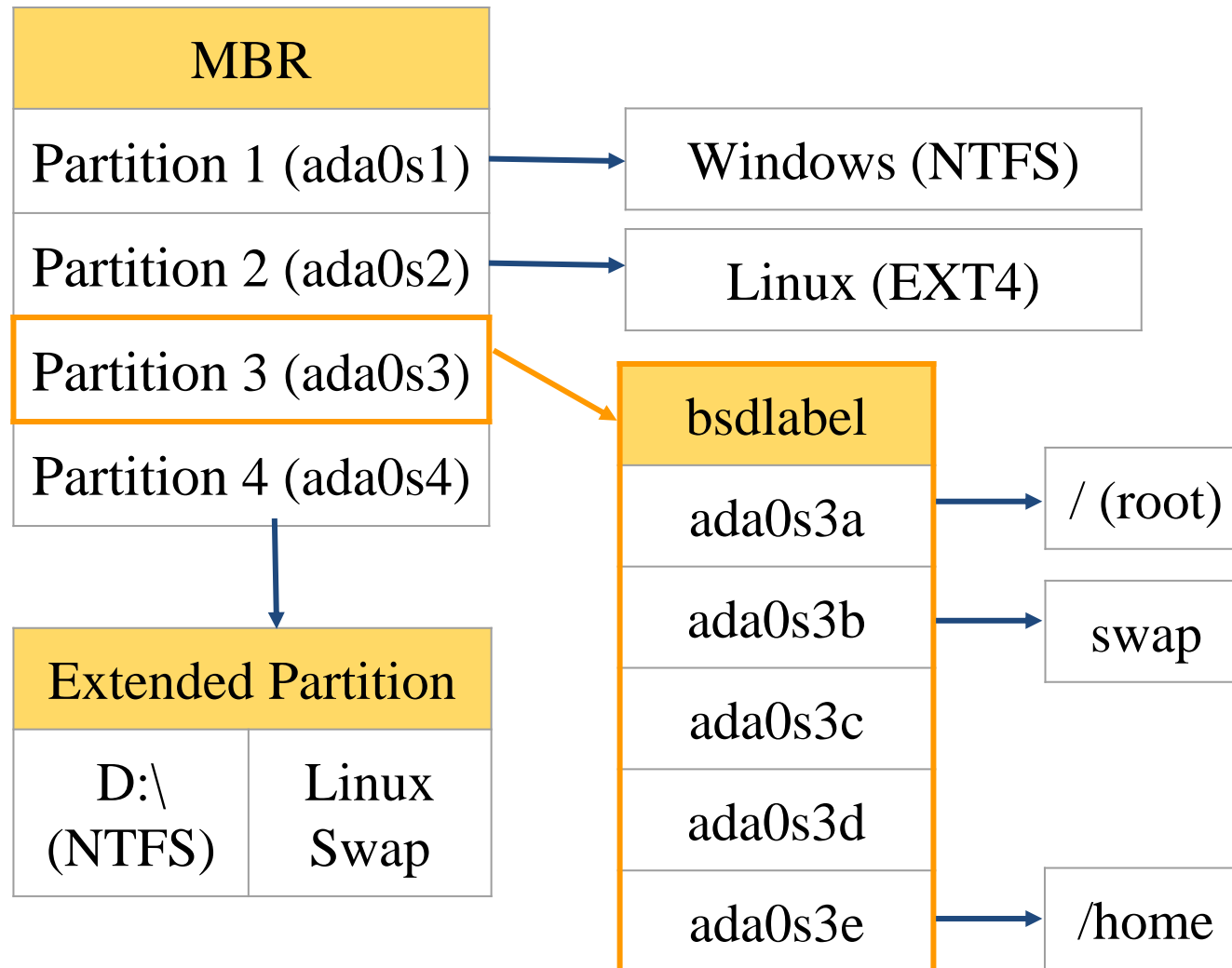

FreeBSD View of Disk

- What is the meaning of `ada0s1a`
 - Disk name
 - `ada` : IDE, SATA
 - `da`: SCSI, usb stick
 - Partition (slice)
 - Primary partition: `s1 ~ s4`
 - Extended partition: `s5 ~ sn`
 - Label in each slice
 - `a`: root partition /
 - `b`: swap
 - `c`: entire slice
 - `defgh`: `/usr`, `/home`, ...

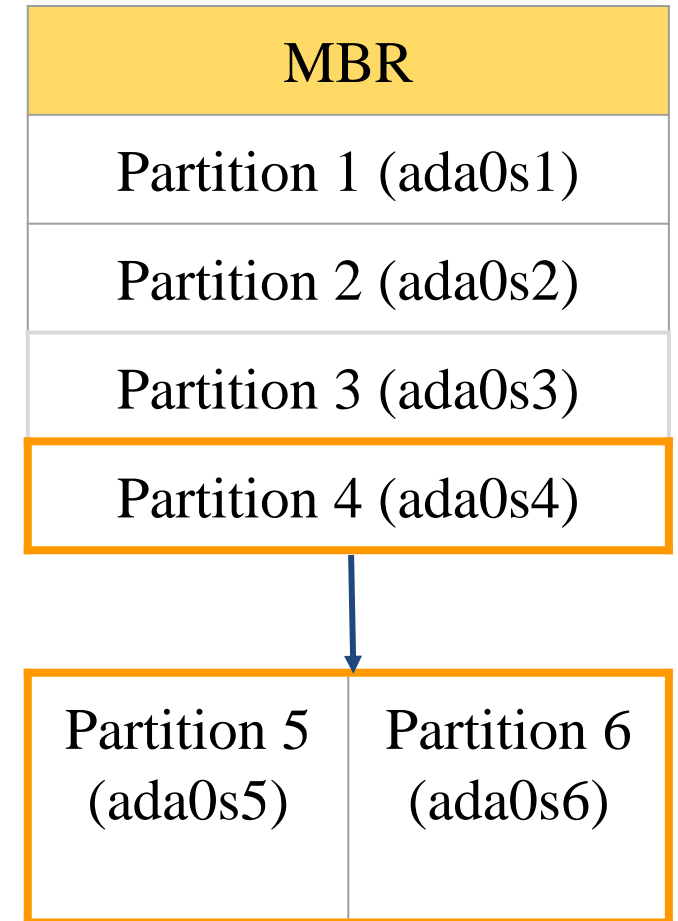

Know Your Hardware

- CPU
 - 32bit or 64bit
 - Intel 、 AMD
 - Architecture: amd64, i386 (powerpc, mips, riscv, ...)
- RAM
 - Size, Speed
- HDD
 - Size, amount, SATA, SCSI, SAS, ...
- Graphics
 - Brand, ram size
- Sound
 - Brand

Know Your Hardware

- Network Interface and settings
 - Brand
 - Media type (10/100, 1G, 2.5G, 10G, ...)
 - Hostname, IP, Netmask, Default gateway, DNS
- Other Special devices
 - `pciconf -lv`

Pre-Installation Tasks

- Virtual Machine
 - VirtualBox 、 VMware 、 KVM
- Network Information
 - IP address
 - Subnet mask
 - Default router IP address
 - domain name of the local network
 - DNS server IP address(es)
- Prepare the Installation Media
 - <https://www.freebsd.org/where.html>
 - Installer image (iso, disc1 or dvd1)

bsdinstall

- [bsdinstall \(8\)](#)
- An easy to use, text-based installation program
 - Beginning with FreeBSD 9.0-RELEASE
- Official handbook
 - <https://www.freebsd.org/doc/handbook/using-bsdinstall.html>
 - https://www.freebsd.org/doc/zh_TW/books/handbook/using-bsdinstall.html

bsdinstall - (1)

- Boot screen of FreeBSD 14.1
 - Press Enter or Wait for autoboot

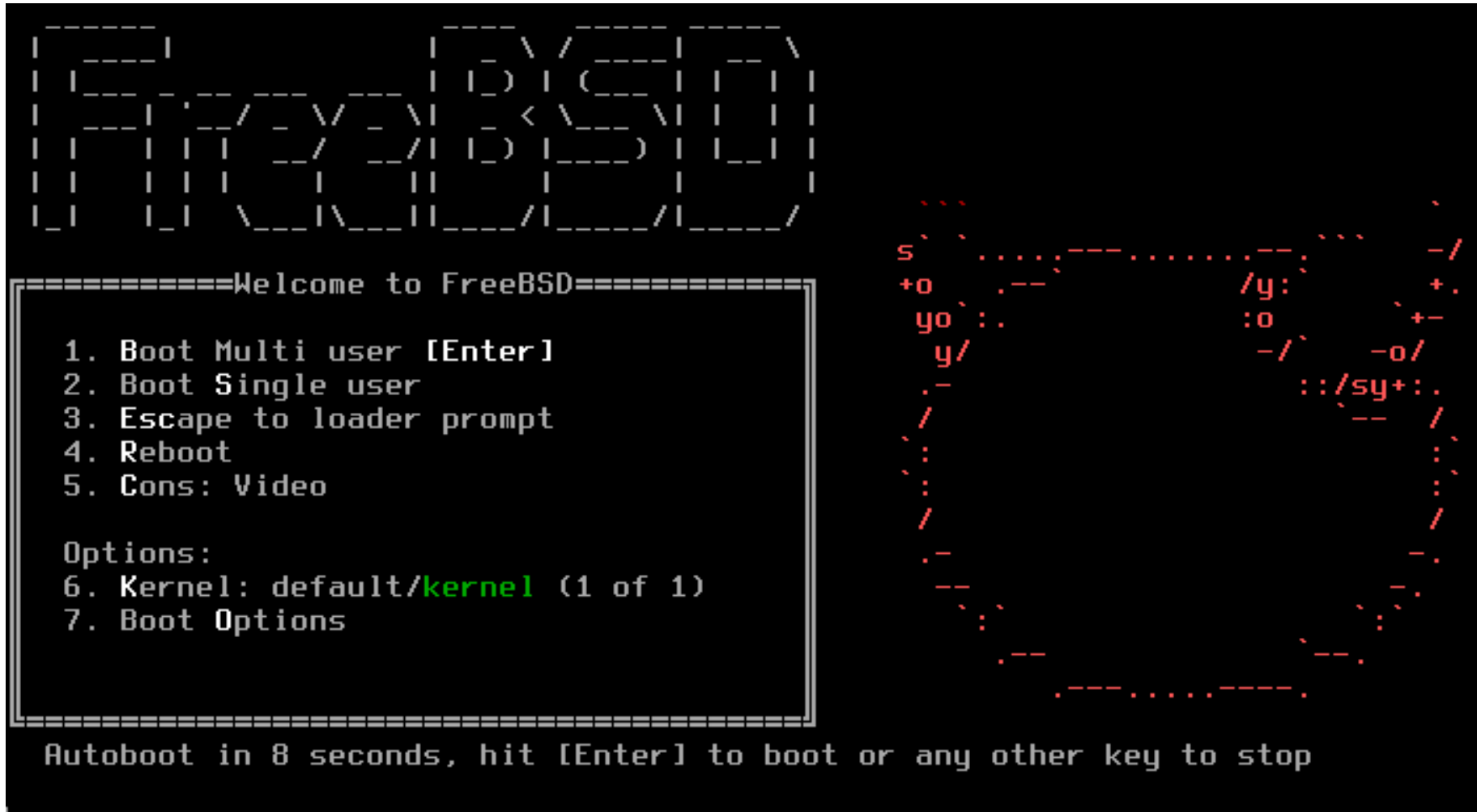

bsdinstall – (2)

- Install、Shell、Live System
 - Choose “Install”

```
-----Welcome-----  
Welcome to FreeBSD! Would you like to  
begin an installation or use the live  
system?  
-----  
[ Install ] [ Shell ] [ Live System ]
```

bsdinstall – (3)

- Select keymap
 - Select “Continue with default keymap”

```
FreeBSD Installer
-----
                                Keymap Selection
The system console driver for FreeBSD defaults to standard "US"
keyboard map. Other keymaps can be chosen below.
-----
>>> Continue with default keymap
->- Test default keymap
( ) Armenian phonetic layout
( ) Belarusian
( ) Belgian
( ) Belgian (accent keys)
( ) Brazilian (accent keys)
( ) Brazilian (without accent keys)
( ) Bulgarian (BDS)
( ) Bulgarian (Phonetic)
( ) Canadian Bilingual
( ) Central European
-----
                                  13%
-----
<Select>          <Cancel>
[Press arrows, TAB or ENTER]
```

bsdinstall – (4)

- Setting hostname
 - e.g., xxx.cs.nycu.edu.tw

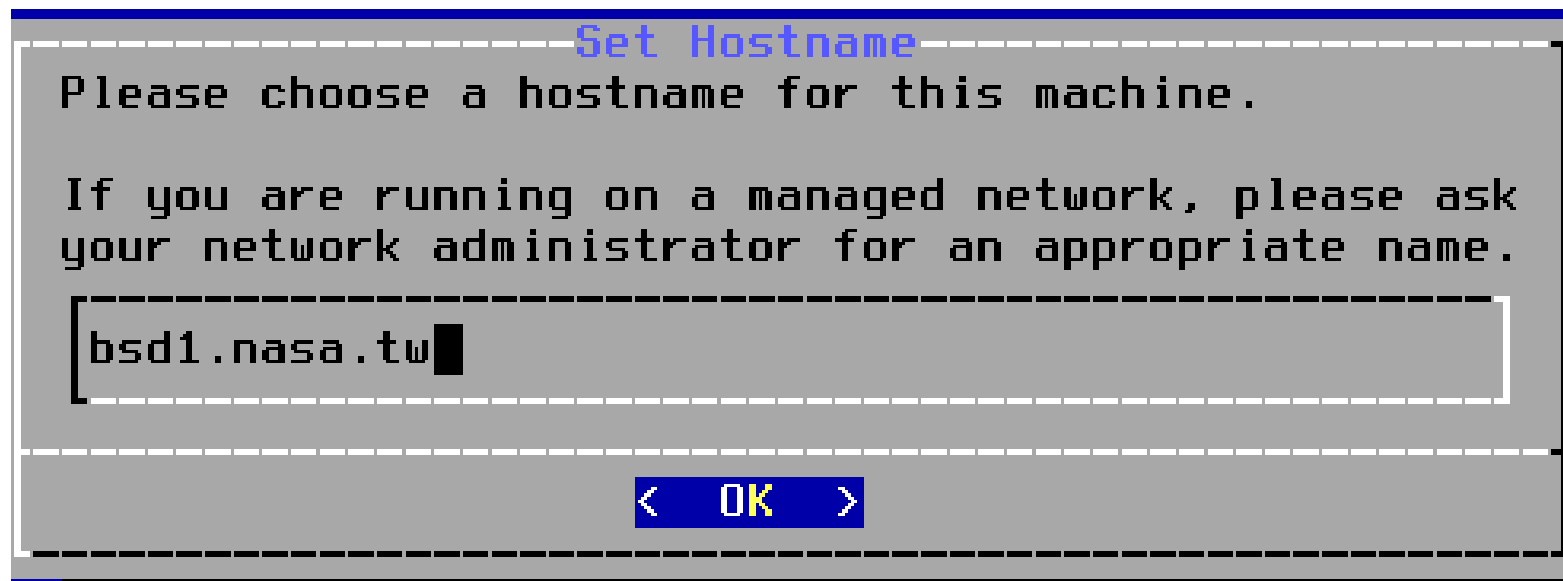

bsdinstall – (5)

- Select components to install
 - use default settings

```
-----Distribution Select-----
Choose optional system components to install:

[ ] base-dbg      Base system (Debugging)
[*] kernel-dbg   Kernel (Debugging)
[ ] lib32-dbg    32-bit compatibility libraries (Debugging)
[*] lib32        32-bit compatibility libraries
[ ] ports        Ports tree
[ ] src          System source tree
[ ] tests        Test suite

< JK >
```

bsdinstall – (6)

- Partitioning methods
 - Shell – [gpart\(8\)](#)、[fdisk\(8\)](#)、[bsdlabel\(8\)](#)
 - Use Auto (ZFS)

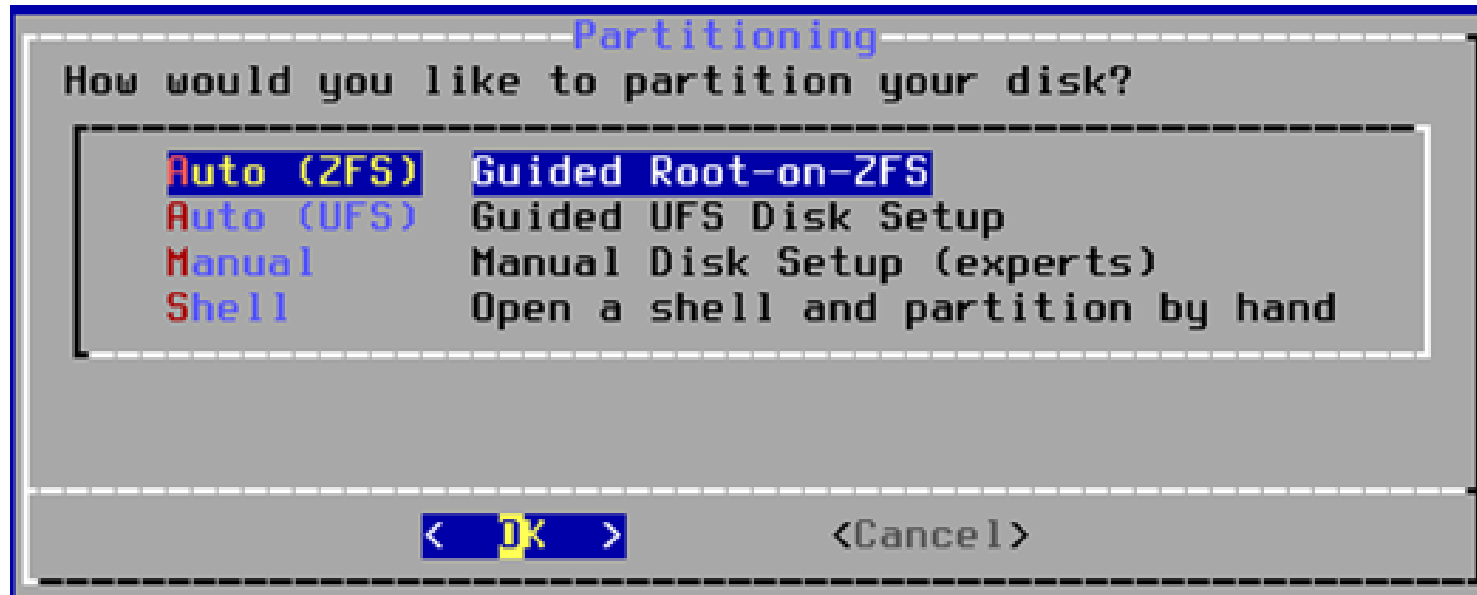

bsdinstall – (7) Auto (ZFS)

- Guided Root-on-ZFS
 - Keep the default settings, and choose “Install”

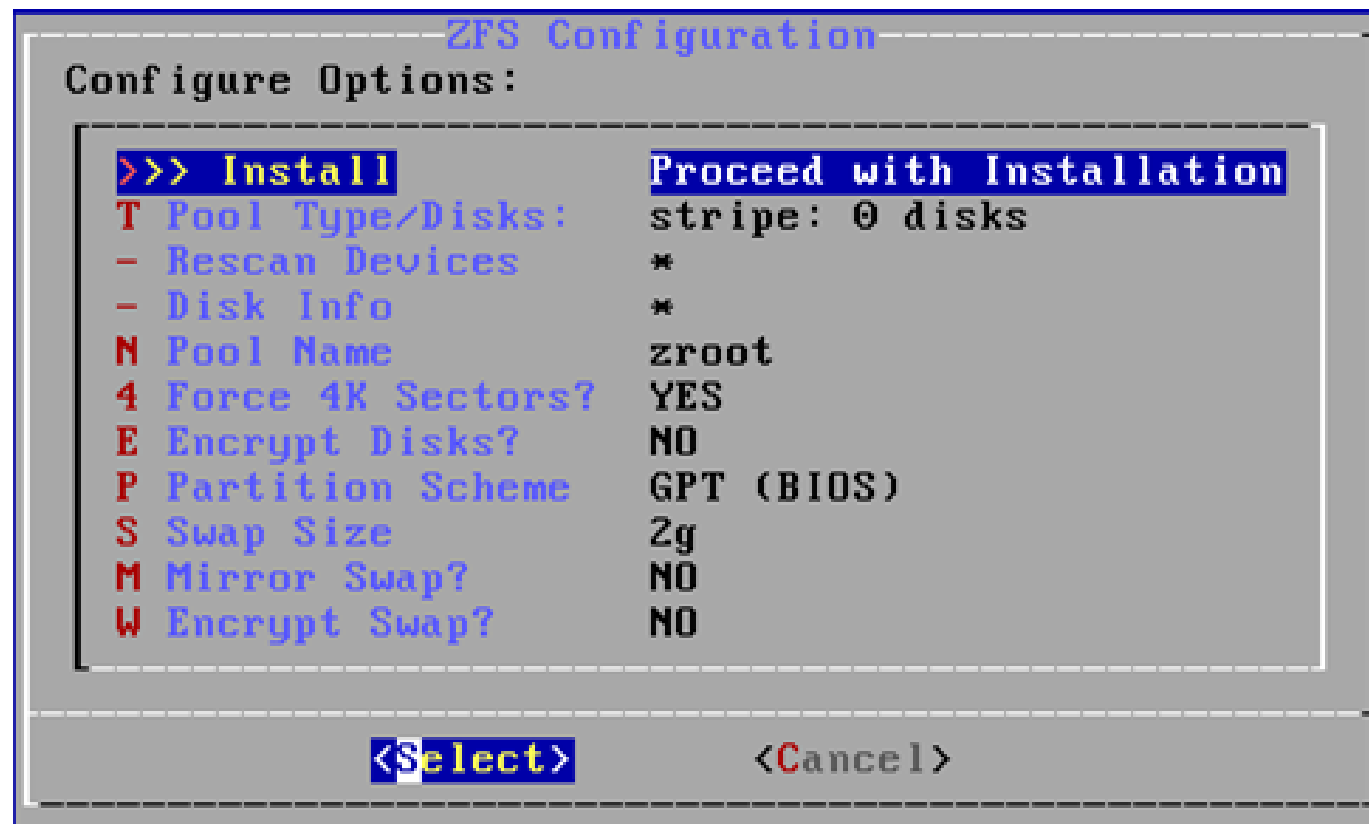

bsdinstall – (8)

- Virtual Device type
 - Stripe (select this type, and add a disk)
 - Mirror
 - RAID10
 - RAID-Z 1, 2, 3
- **Caution! Backup important data when using dual OS**

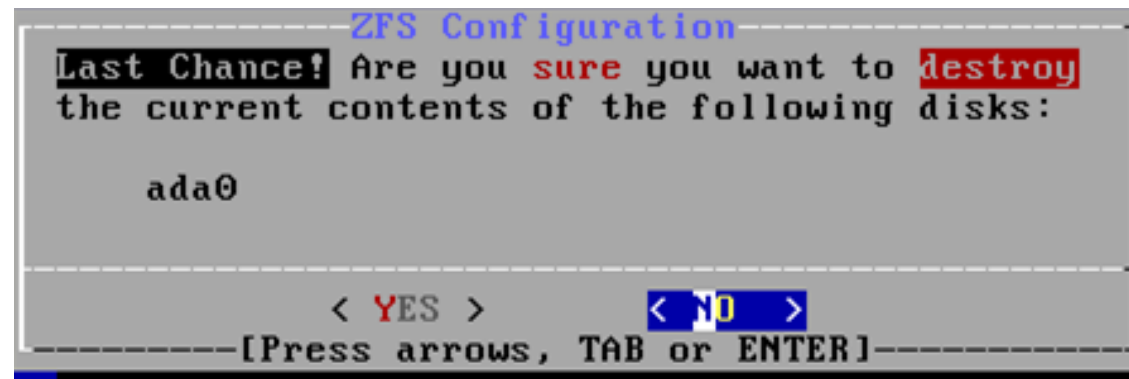
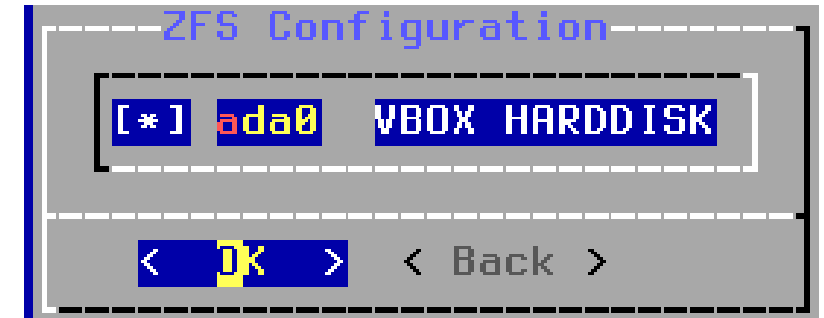
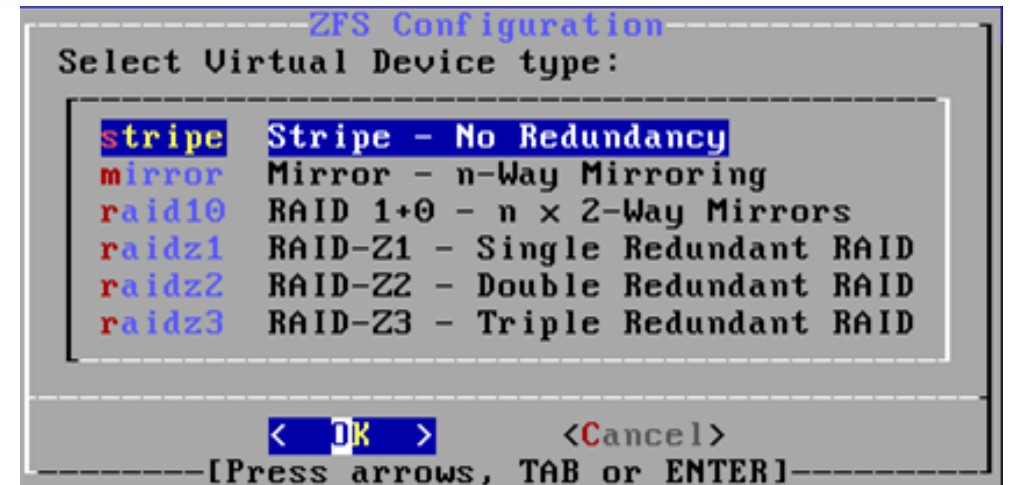

bsdinstall – (9)

- Fetching → Checksum Verification → Extraction

```
FreeBSD Installer
-----

Archive Extraction
Extracting distribution files...

base.txz... - [ 96% ]
kernel.txz [ Pending ]
lib32.txz [ Pending ]

Overall Progress:
[ 32% ]

24664 files read @ 2,242.0 files/sec. [1/2 busy/wait]
```

bsdinstall – (10)

- Post-installation
 - root password
 - Network interfaces
 - Wired – Static IPv4 / DHCP / Static IPv6 / SLAAC
 - Wireless
 - DNS
 - Time Zone
 - Services
 - System security hardening options
 - Add users

Post-installation

- Setting the root Password

```
FreeBSD Installer
=====
Please select a password for the system management account (root):
Typed characters will not be visible.
Changing local password for root
New Password:█
```

Post-installation

- Select a network interfaces
- Configuring IPv4 Networking with DHCP

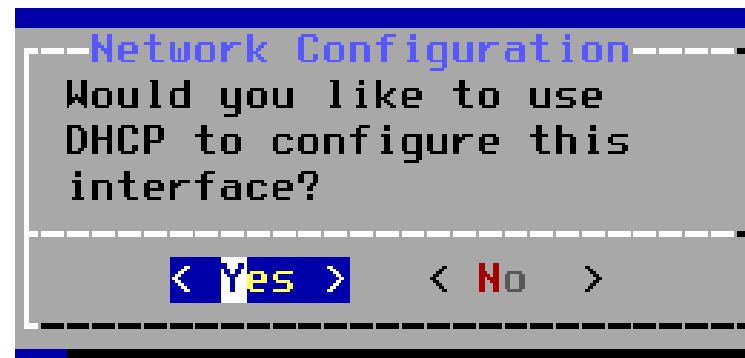
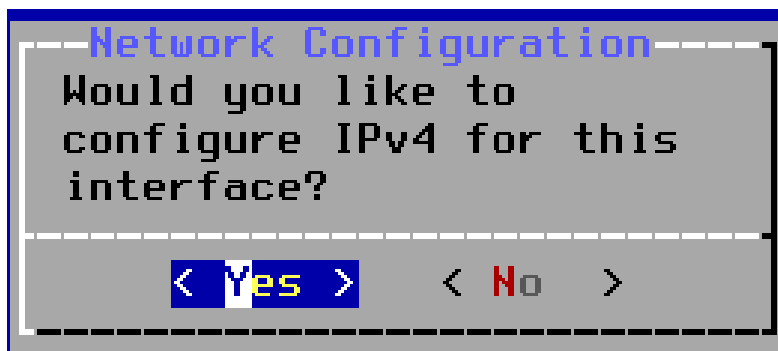
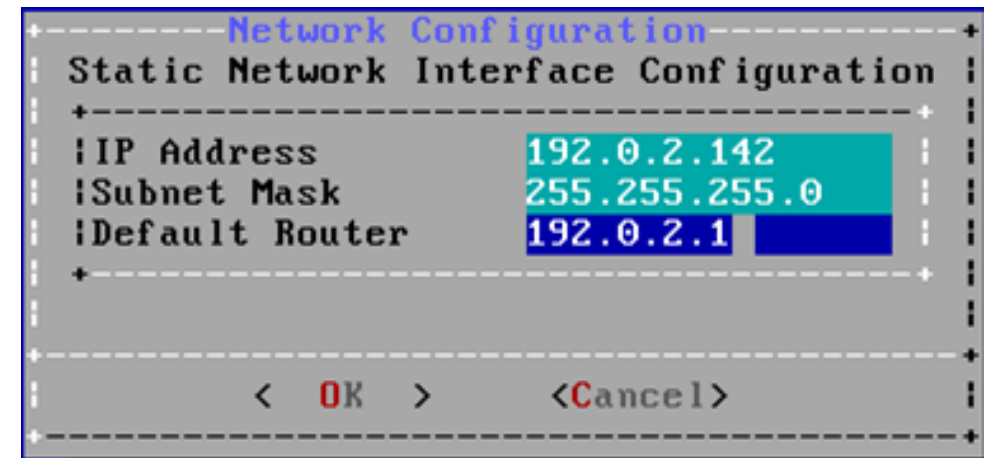
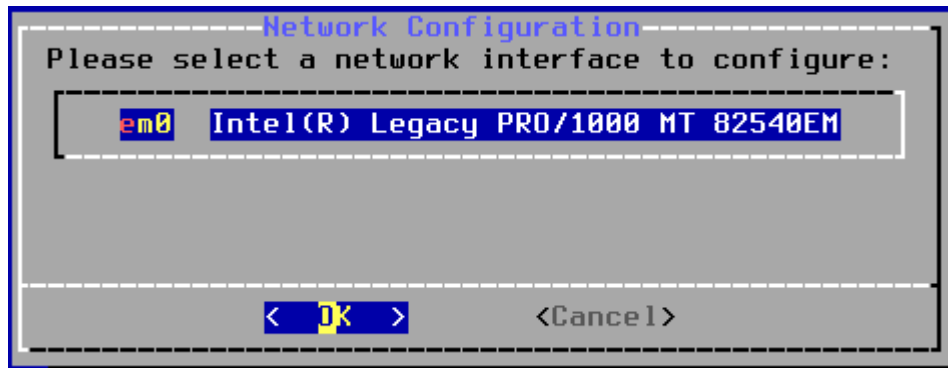

If "No" is pressed

Post-installation

- Configuring IPv6 Networking
 - IPv6 Stateless Address Auto configuration (SLAAC)
 - <http://tools.ietf.org/html/rfc4862>
 - IPv6 is optional to you. **We don't use IPv6 in this class.**

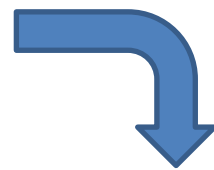
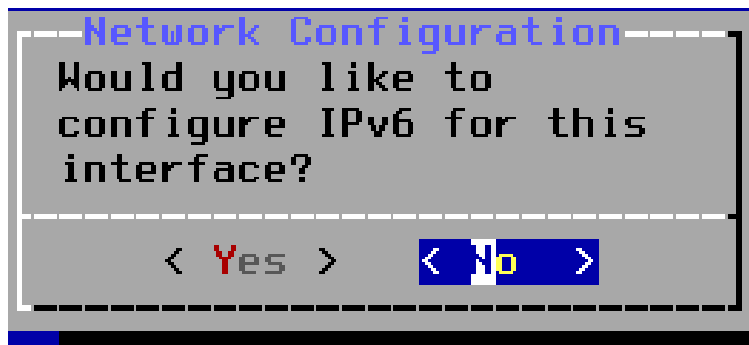

If "Yes" is pressed

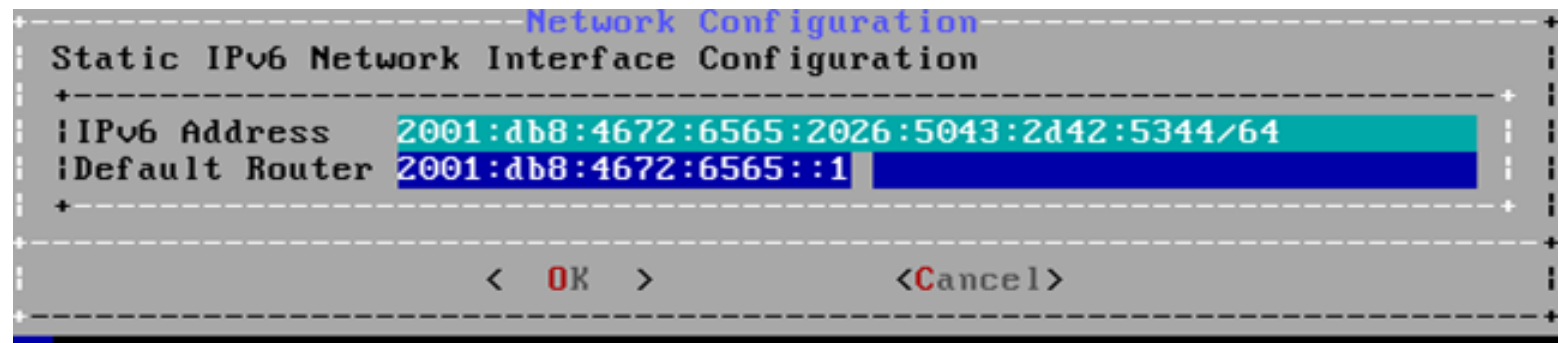

Post-installation

- Configuring DNS

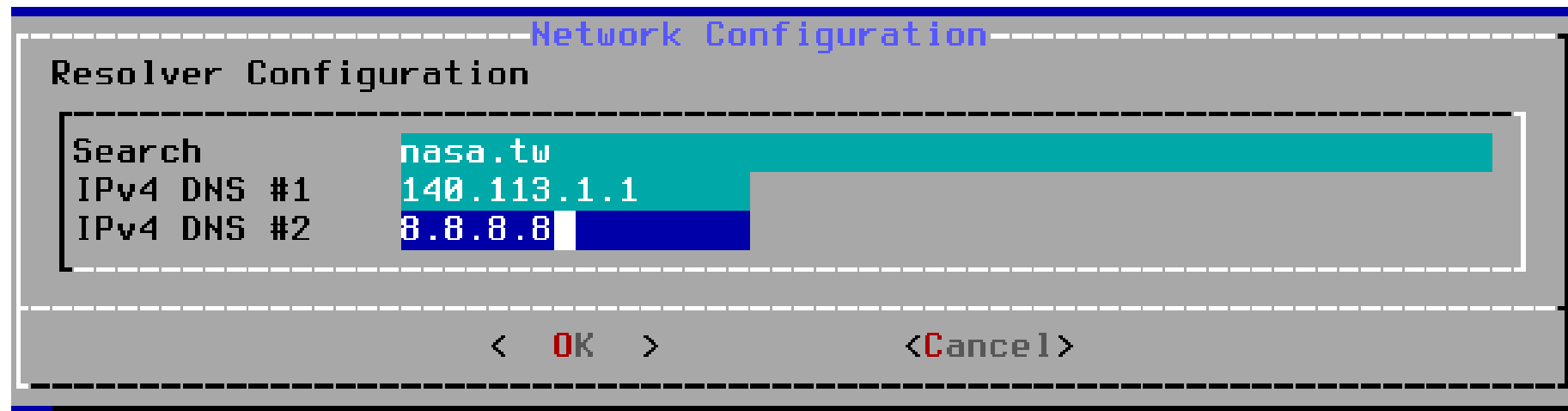

Post-installation

- Setting the Time Zone
 - Asia → Taiwan

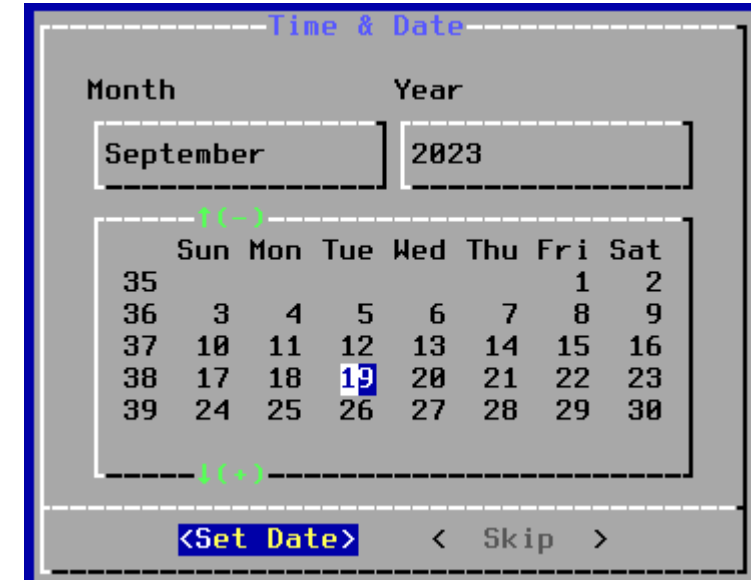
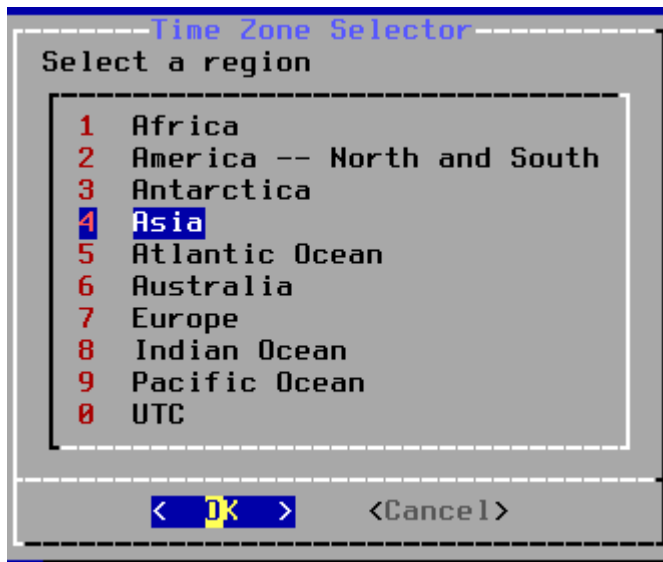

Post-installation

- Selecting services to be enabled at boot
 - Enable sshd, ntpd, ntpd_sync_on_start (i.e., ntpdate)
 - Disable dumpdev

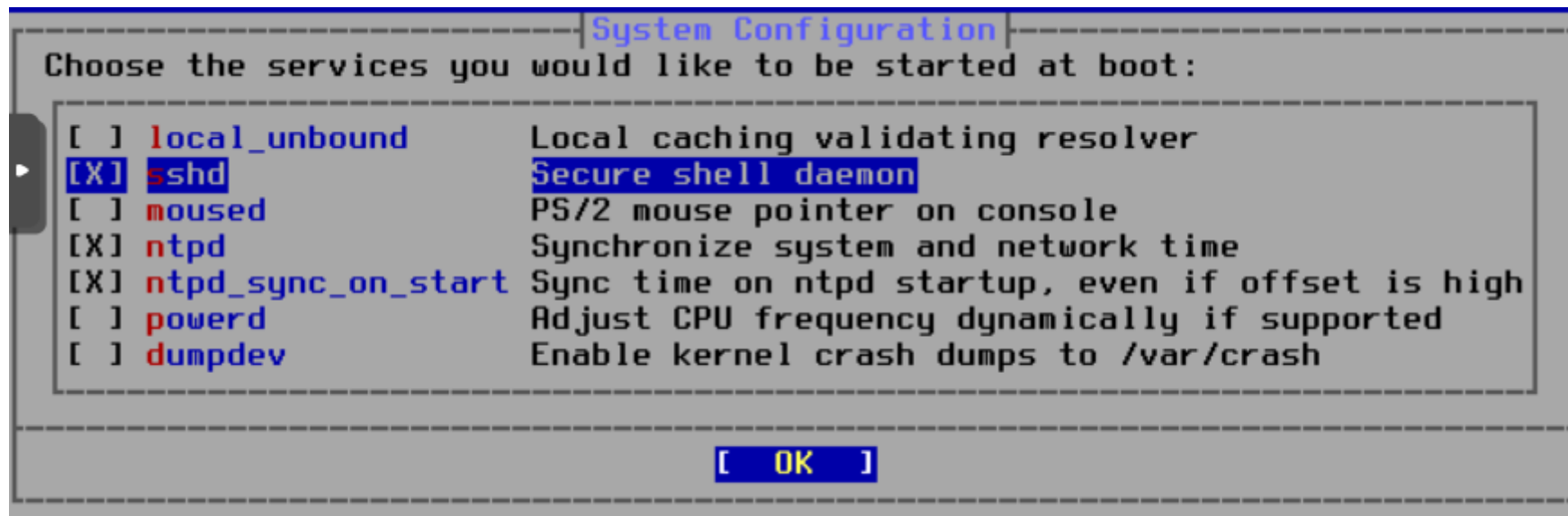

Post-installation

- Selecting system security hardening options
 - Use default settings

```
System Hardening
Choose system security hardening options:
[ ] 0 hide_uids      Hide processes running as other users
[ ] 1 hide_gids      Hide processes running as other groups
[ ] 2 hide_jail      Hide processes running in jails
[ ] 3 read_msgbuf    Disable reading kernel message buffer for unprivil
[ ] 4 proc_debug     Disable process debugging facilities for unprivile
[ ] 5 random_pid     Randomize the PID of newly created processes
[ ] 6 clear_tmp      Clean the /tmp filesystem on system startup
[ ] 7 disable_syslogd Disable opening Syslogd network socket (disables r
[ ] 8 disable_sendmail Disable Sendmail service
[ ] 9 secure_console Enable console password prompt
[ ] 10 disable_ddtrace Disallow DTrace destructive-mode
< OK >
```

Post-installation

- Add Users
 - Username - **tsaimh**
 - Full name - **Meng-Hsun Tsai**
 - Uid - User ID. Typically **left blank for default**.
 - Login group - The user's group. - "**staff**" is good for you
 - Invite user into other groups? - **wheel**
 - Login class - Typically **left blank for default**.
 - Shell - The interactive shell for this user. CSIT use **tcsh**.
 - Home directory - The user's home directory. **Use default**.
 - Home directory permissions - The **default** is usually correct.
 - Enable ZFS encryption - **no**

Post-installation

- Add Users (Cont.)
 - Use password-based authentication? - Typically "yes".
 - Use an empty password? - Typically "no".
 - Use a random password? - Typically "no".
 - Enter password - The **actual password** for this user.
 - Enter password again - The **password** must be **typed again** for verification.
 - Lock out the account after creation? - Typically "no".

Post-installation

- Final Configuration

```
Final Configuration
Setup of your FreeBSD system is nearly complete. You can now modify
your configuration choices. After this screen, you will have an
opportunity to make more complex changes using a shell.

Exit          Apply configuration and exit installer
Add User      Add a user to the system
Root Password Change root password
Hostname      Set system hostname
Network       Networking configuration
Services      Set daemons to run on startup
System Hardening Set security options
Time Zone     Set system timezone
Handbook      Install FreeBSD Handbook (requires network)

< DK >
```

Post-installation

- Make sure the configuration is correct before exiting
- Remove installation media

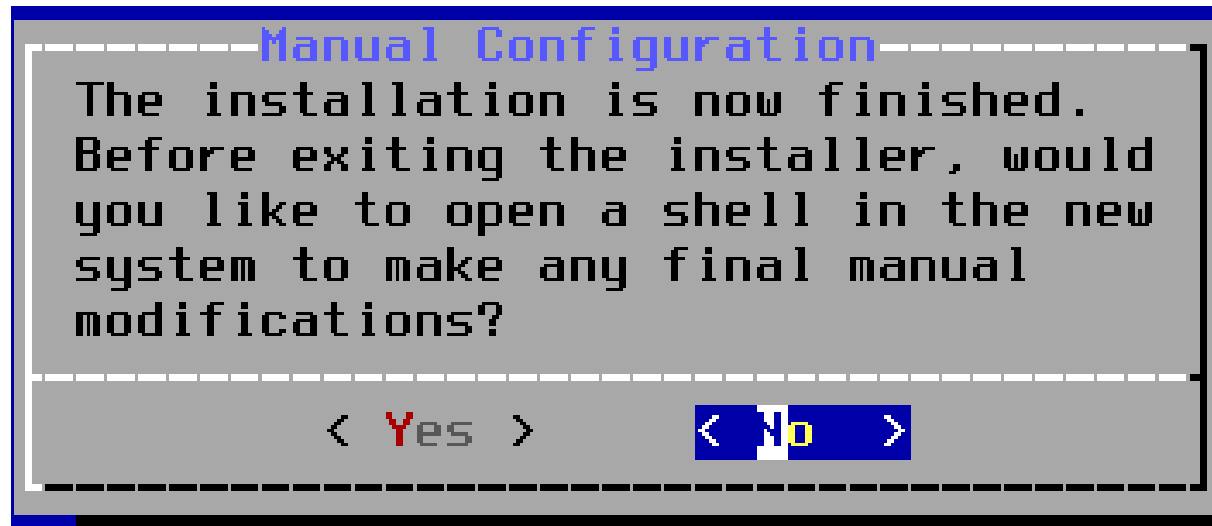

Post-installation

- Update your system to latest patch (login as `root`)
 - `$ freebsd-update fetch install`
- Check your installed patch version
 - `$ freebsd-version`
 - Should be "14.1-RELEASE-p4" (or any larger patch number)
 - Remember to reboot from the installed kernel