

FAMP / LAMP

FreeBSD/Linux/Apache/MySQL/PHP

tsaimh (2022-2024, CC BY)

jnlin (2019-2021, CC BY)

? (?-2018)

陽明交大資工系資訊中心

Information Technology Center of Department of Computer Science, NYCU

Introduction

- Web service
 - Apache
 - GWS, Nginx, IIS
- SQL service
 - MySQL, MariaDB
 - MS SQL, Oracle DB, PostgreSQL
- NoSQL service
 - MongoDB
- Web backend language
 - Golang, Python, Node.js, PHP

Outline

- Introduction
 - Apache
 - MySQL
 - PHP
- Installation and Administration
 - MySQL
 - Apache
 - PHP
- Appendix
 - phpMyAdmin
 - lighttpd
 - FastCGI

Overview

by Shmuel Csaba Otto Traian; CC BY-SA 4.0; created 2013-09-10, last updated 2014-03-28

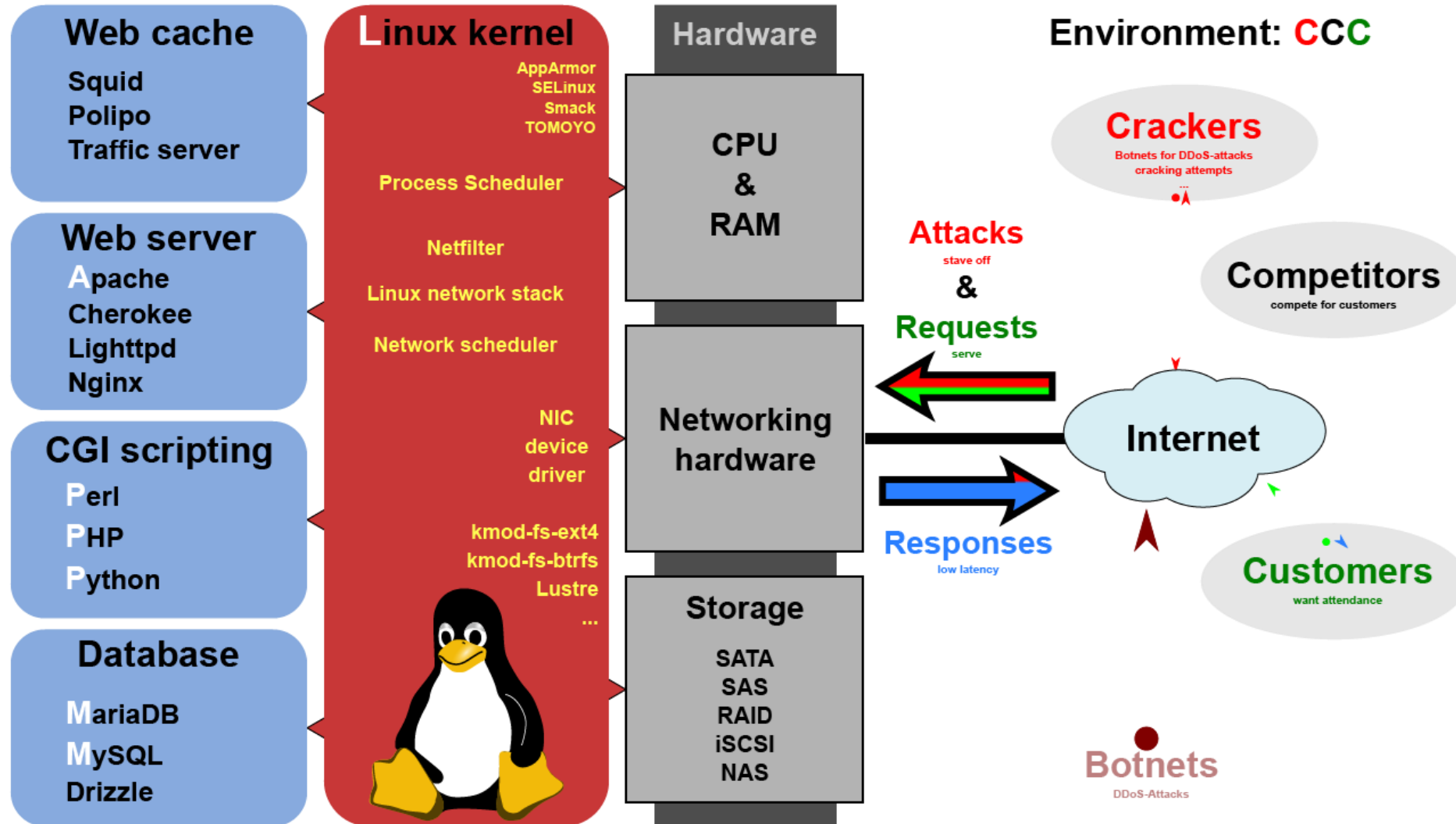

<https://commons.wikimedia.org/w/index.php?curid=28224098>

Apache

- Apache Software Foundation: <http://www.apache.org/>
- Apache HTTP Server Project: <http://httpd.apache.org/>
- Web httpd server that supports
 - HTTP/2
 - Modular design
 - Can be customized by writing modules using Apache module API
 - Freely available across many platforms
- Two main parts
 - Core: implements basic functions and provide the interface for Apache modules
 - Modules: extends or overrides the function of Core
 - Example: Access control, logging, CGI, proxy, cache control, PHP...

How Apache Works – request and response

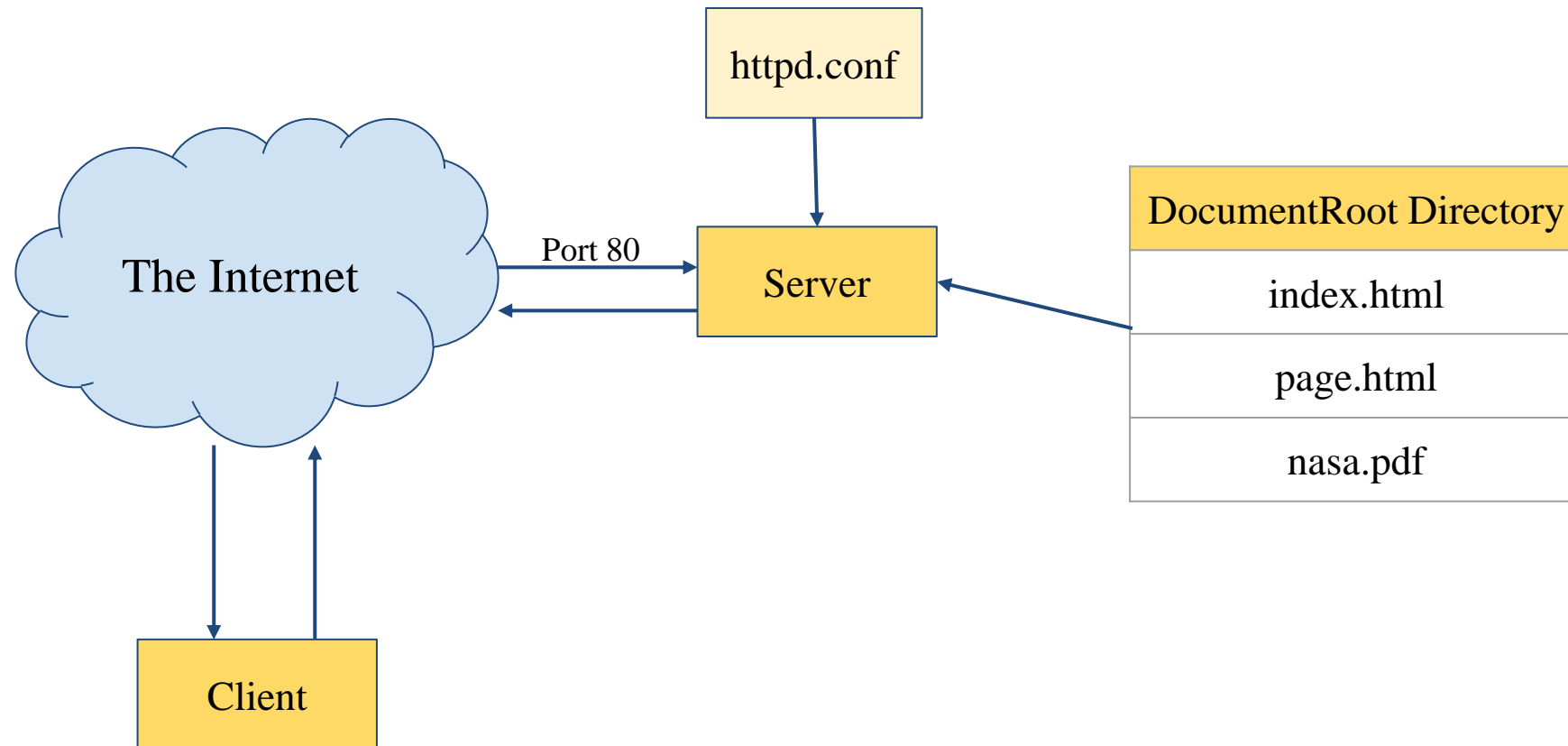

How Apache Works – each request-response

- Apache breaks client request into several steps which are implemented as modules

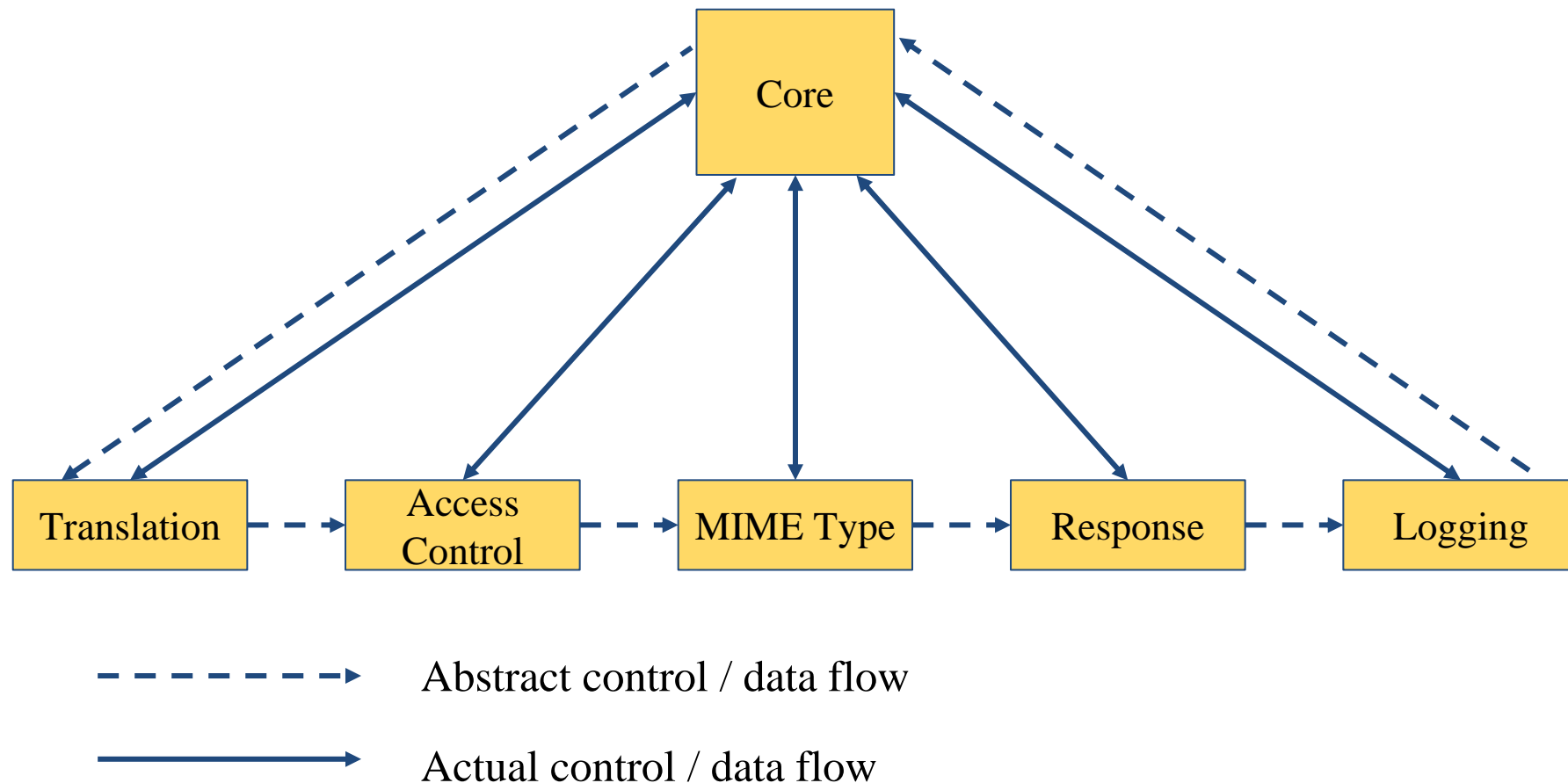

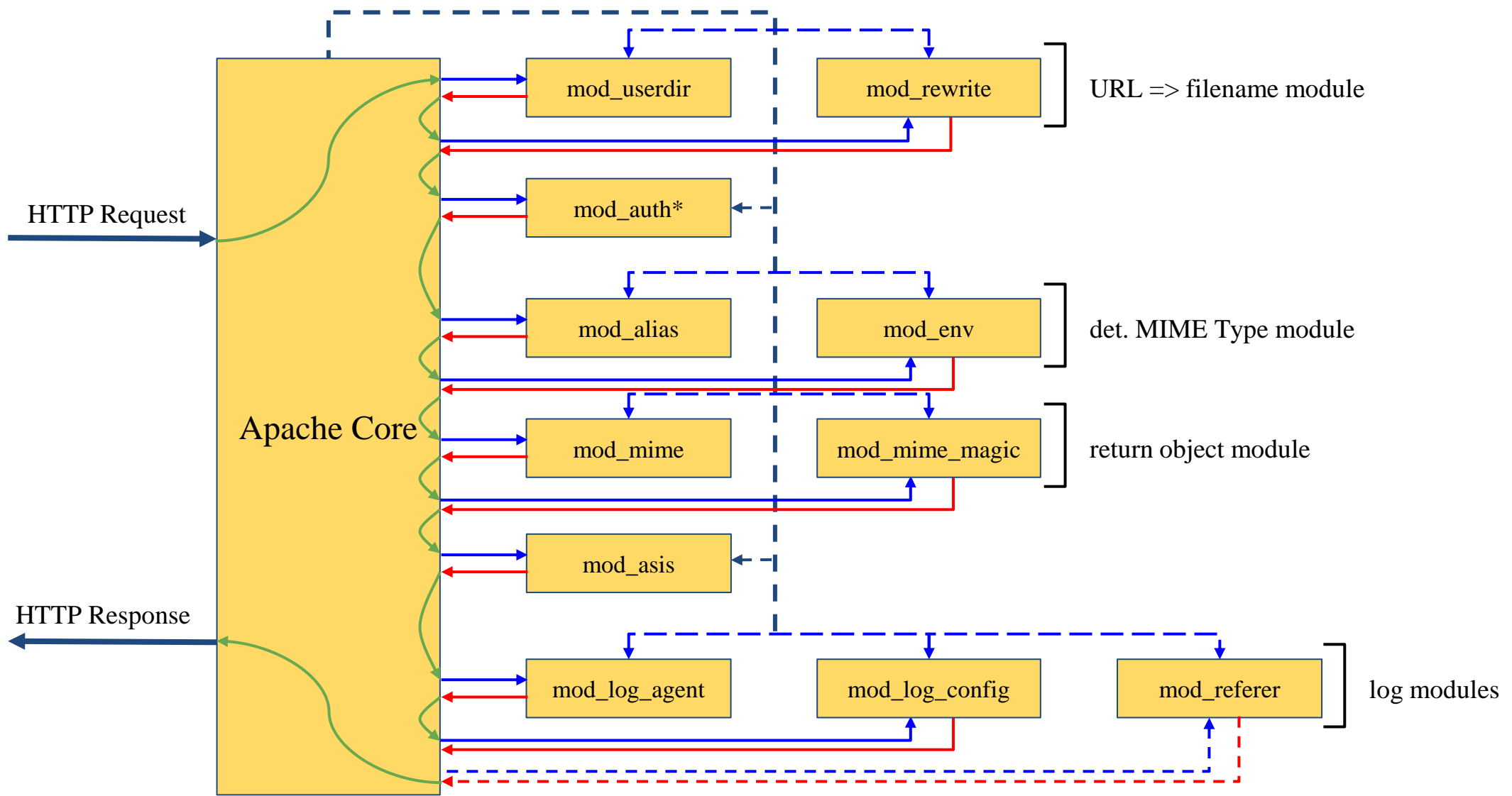

URL => filename module

det. MIME Type module

return object module

log modules

Apache Core

HTTP Request

HTTP Response

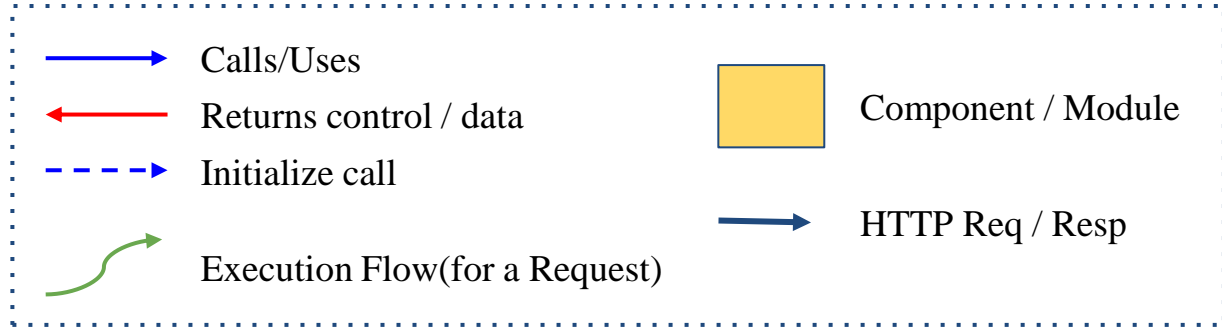

Apache with mod_ssl

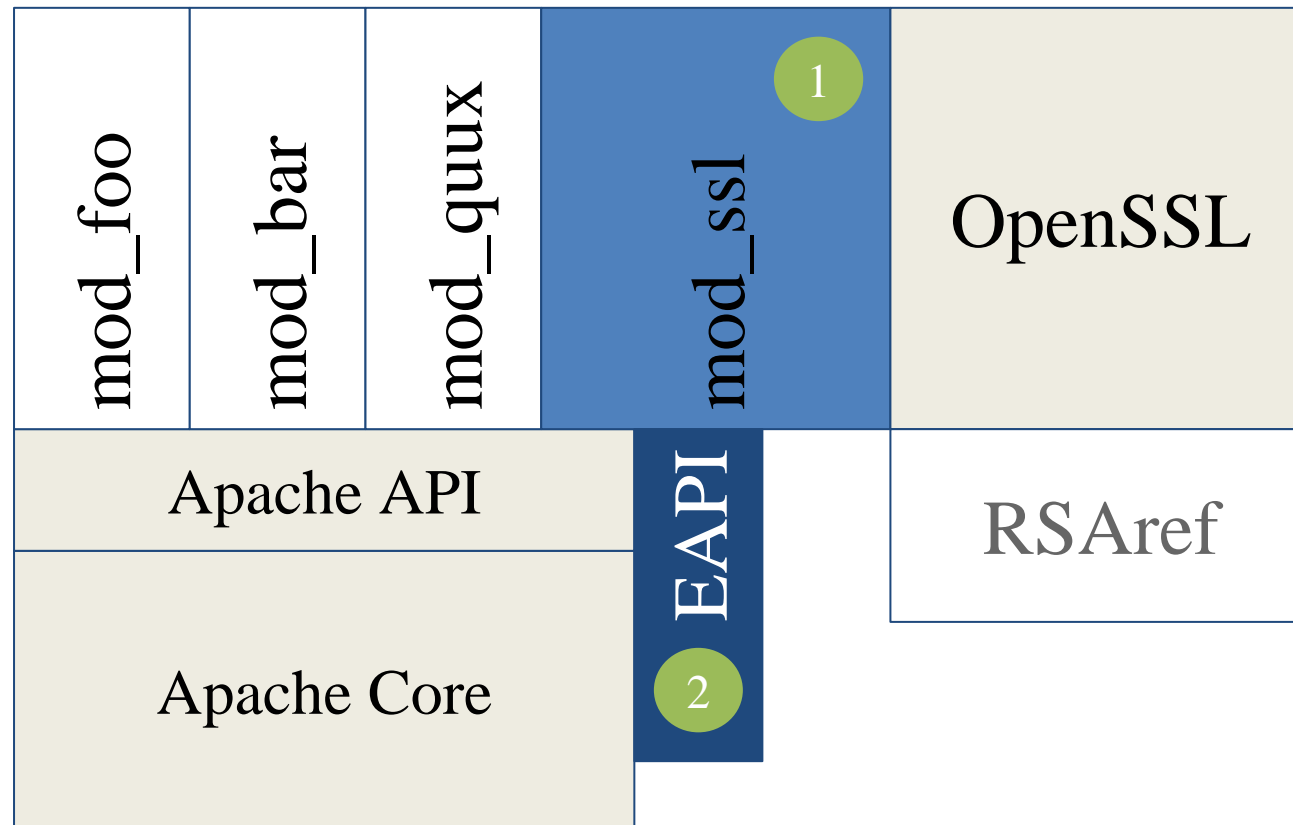

MySQL (1)

- SQL (Structured Query Language)
 - The most popular computer language used to create, modify, retrieve and manipulate data from **relational database** management systems.
 - Introduction to SQL: <http://www.1keydata.com/tw/sql/sql.html>
- A **multithreaded, multi-user, SQL** Database Management System.
- Owned and sponsored by a Swedish company MySQL AB, acquired by Sun Microsystems 2008. Oracle acquired Sun in 2009.
 - Forked version: [MariaDB](#), [Percona Server](#)
- Official Site: <http://www.mysql.com>
- Documentation: <http://dev.mysql.com/doc>

MySQL (2)

- Features:
 - Writing in C/C++, tested by many compilers, **portable to many platforms**.
 - AIX, FreeBSD, HP-UX, Linux, Mac OS, Solaris, Windows, ...etc.
 - Providing APIs for C/C++, Java, Perl, PHP, Python, Ruby, Tcl, ...etc.
 - **Multi-threaded** kernel, supporting systems with multiple CPUs.
 - Optimized algorithm for **SQL** Query.
 - Multi-Language (coding) Supports.
 - Lots of connecting method: TCP/IP, ODBC, JDBC, Unix domain socket.
 - **Free Software** (GNU General Public License version 2)
 - Popular for web applications

PHP

- PHP: Hypertext Preprocessor
 - A widely-used Open Source general-purpose scripting language.
 - Originally designed to create dynamic web pages, PHP's principal focus is server-side scripting.
 - PHP scripts can be embedded into HTML.
 - The LAMP architecture has become popular in the Web industry as a way of deploying inexpensive, reliable, scalable, secure web applications.
- Official Site: <http://php.net/>

Installation and Administration

MySQL, Apache, PHP, phpMyAdmin

陽明交大資工系資訊中心

Information Technology Center of Department of Computer Science, NYCU

Installing MySQL (1)

- Steps

- \$ cd /usr/ports/databases/mysql57-server/
- \$ make OPTIONS install clean

You may use the following build options:

```
WITH_CHARSET=charset Define the primary built-in charset (latin1).
WITH_XCHARSET=list Define other built-in charsets (may be 'all').
WITH_COLLATION=collate Define default collation (latin1_swedish_ci).
WITH_OPENSSL=yes Enable secure connections
                        (define WITHOUT_YASSL for backward compatibility).
WITH_LINUXTHREADS=yes Use the linuxthreads pthread library.
WITH_PROC_SCOPE_PTH=yes Use process scope threads
                        (try it if you use libpthread).
WITH_FAST_MUTEXES=yes Replace mutexes with spinlocks.
BUILD_OPTIMIZED=yes Enable compiler optimizations
                    (use it if you need speed).
BUILD_STATIC=yes Build a static version of mysqld.
                    (use it if you need even more speed).
WITH_NDB=yes Enable support for NDB Cluster.
```

Installing MySQL (2)

- OPTIONS:
 - WITH_CHARSET=utf8
 - WITH_XCHARSET=ascii,big5,... (all)
- Installed...

```
==> SECURITY REPORT:
```

```
    This port has installed the following files which may act as network  
    servers and may therefore pose a remote security risk to the system.
```

```
/usr/local/libexec/mysqld
```

```
    This port has installed the following startup scripts which may cause  
    these network services to be started at boot time.
```

```
/usr/local/etc/rc.d/mysql-server
```

Installing MySQL (3)

- Startup script...

```
#  
# Add the following line to /etc/rc.conf to enable mysql:  
# mysql_enable (bool): Set to "NO" by default.  
#                               Set it to "YES" to enable MySQL.  
# mysql_limits (bool): Set to "NO" by default.  
#                               Set it to yes to run `limits -e -U mysql`  
#                               just before mysql starts.  
# mysql_dbdir (str): Default to "/var/db/mysql"  
#                               Base database directory.  
# mysql_args (str): Custom additional arguments to be passed  
#                               to mysqld_safe (default empty).  
#
```

Managing MySQL (1)

- Configuration file
 - Copy config file
 - `$ cd /usr/local/share/mysql`
 - `$ cp my-huge.cnf /usr/local/etc/my.cnf`
 - Edit `/usr/local/etc/my.cnf`
- Start mysql daemon
 - Using startup script
 - `$ /usr/local/etc/rc.d/mysql-server start`

Managing MySQL (2)

- Test
 - `$ mysql -u root -p`
 - The initial password for root is empty

```
$ mysql -u root -p
Enter password:
Welcome to the MySQL monitor.  Commands end with ; or \g.
Your MySQL connection id is 1
Server version: 5.1.41-log FreeBSD port: mysql-server-5.1.41

Type 'help;' or '\h' for help. Type '\c' to clear the current input statement.

mysql> show databases;
+-----+
| Database          |
+-----+
| information_schema |
| mysql             |
| test              |
+-----+
3 rows in set (0.06 sec)
```

Managing MySQL (3)

- Securing initial accounts
 - Two initial accounts
 - root
 - anonymous

```
mysql> SELECT Host, User From mysql.user;
+-----+-----+
| Host          | User  |
+-----+-----+
| 127.0.0.1     | root  |
| nasa.cs.nctu.edu.tw |      |
| nasa.cs.nctu.edu.tw | root  |
| localhost    |      |
| localhost    | root  |
+-----+-----+
```

```
mysql> UPDATE mysql.user SET Password = PASSWORD('test123') WHERE User = 'root';
Query OK, 3 rows affected (0.08 sec)
Rows matched: 3  Changed: 3  Warnings: 0

mysql> FLUSH PRIVILEGES;                # Reload the grant tables
Query OK, 0 rows affected (0.00 sec)

mysql> SET PASSWORD FOR 'root'@'localhost' = PASSWORD('ttt123');
Query OK, 0 rows affected (0.02 sec)
```

Installing Apache (1)

- Steps
 - `$ cd /usr/ports/www/apache24/`
 - `$ make install clean`

- Options
 - A lot of options for modules
 - `WITH_SSL` (default)
 - `WITH_MPM=worker`
 - `WITH_THREADS=yes`
 - `WITH_SUEXEC=yes`

Installing Apache (2)

- Installed...

```
To run apache www server from startup, add apache22_enable="YES"
in your /etc/rc.conf. Extra options can be found in startup script.
```

```
Your hostname must be resolvable using at least 1 mechanism in
/etc/nsswitch typically DNS or /etc/hosts or apache might
have issues starting depending on the modules you are using.
```

```
==> SECURITY REPORT:
```

```
    This port has installed the following binaries which execute with
    increased privileges.
```

```
/usr/local/sbin/suexec
```

- Startup script

- `/usr/local/etc/rc.d/apache24`
- `apache24_http_accept_enable`

Apache configuration – Configuration files

- Location
 - The default location of apache (in ports) is /usr/local/etc/apache24
 - Major configuration file: httpd.conf
 - Other configuration files could be included. (setting in httpd.conf)
 - extra/httpd-*.conf, Includes/*.conf
- Two types
 - Global settings
 - Server configurations
 - Options of modules
 - Directory Configuration
 - Local setting for certain directory

Apache configuration – Global Settings (httpd.conf)

- Server configuration
 - Listen 80
 - ServerAdmin tsaimh@cs.nctu.edu.tw
 - ServerName nasa.cs.nctu.edu.tw
 - DocumentRoot "/home/wwwadm/data"
 - Remember create DocumentRoot directory if you modify it
- Options of modules
- Include supplemental configuration files
 - Include etc/apache22/extra/httpd-*.conf
 - Include etc/apache22/Includes/*.conf

Apache configuration – Directory Configuration (1)

- Configuration parameters

- Options

- All

- ExecCGI

- FollowSymLinks

- Indexs

- MultiViews

- SymLinksIfOwnerMatch

- <http://httpd.apache.org/docs/2.4/mod/core.html#options>

```
<Directory "/home/wwwadm/data">  
    Options Indexes FollowSymLinks MultiViews  
    AllowOverride None  
    Order allow,deny  
    Allow from all  
</Directory>
```

Apache configuration – Directory Configuration (2)

- Configuration parameters
 - AllowOverride
 - All (Read .htaccess)
 - None (ignoring .htaccess)
 - Order
 - Solve collision of deny and allow rules
 - Deny/Allow
 - IP/DN (control access to this directory)

```
<Directory "/home/wwwadm/data">  
    Options Indexes FollowSymLinks MultiViews  
    AllowOverride None  
    Order allow,deny  
    Allow from all  
</Directory>
```

Apache configuration – Options of Modules

- **dir_module**

```
<IfModule dir_module>
    DirectoryIndex index.html
</IfModule>
```

- **alias_module** (http://httpd.apache.org/docs/2.2/mod/mod_alias.html)

```
<IfModule alias_module>
    Redirect /foo http://www.example.com/bar
    Alias /webpath /full/filesystem/path
    ScriptAlias /cgi-bin/ "/usr/local/www/apache22/cgi-bin/"
</IfModule>
```

- **mime_module**

```
DefaultType text/plain
<IfModule mime_module>
    TypesConfig etc/apache22/mime.types
    AddType application/x-compress .Z
    AddHandler cgi-script .cgi
</IfModule>
```

Supplemental configuration – httpd-mpm.conf (Multi-Processing Module)

- Server-pool management (MPM specific)
 - Include etc/apache22/extra/httpd-mpm.conf
- WITH_MPM
 - prefork: non-threaded, pre-forking
 - worker: hybrid multi-process multi-threaded

```
<IfModule mpm_worker_module>
    StartServers          2
    MaxClients           150
    MinSpareThreads      25
    MaxSpareThreads      75
    ThreadsPerChild      25
    MaxRequestsPerChild  0
</IfModule>
```

Supplemental configuration – httpd-userdir.conf

- User home directories
 - Include etc/apache22/extra/httpd-userdir.conf

```
UserDir public_html
UserDir disabled root toor daemon operator bin tty kmem games news man sshd bind proxy
_pflogd _dhcp uucp pop www nobody mailnull smmsp

<Directory "/home/*/public_html">
    AllowOverride FileInfo AuthConfig Limit Indexes
    Options MultiViews Indexes SymLinksIfOwnerMatch IncludesNoExec
    <Limit GET POST OPTIONS>
        Order allow,deny
        Allow from all
    </Limit>
    <LimitExcept GET POST OPTIONS>
        Order deny,allow
        Deny from all
    </LimitExcept>
</Directory>
```

- Methods: <http://www.w3.org/Protocols/rfc2616/rfc2616-sec9.html>

Supplemental configuration – httpd-vhosts.conf

- Virtual hosts
 - Include
etc/apache24/extra/httpd-vhosts.conf
 - Name-based
 - NameVirtualHost
 - <VirtualHost>
 - IP-based
 - <VirtualHost>
 - ServerName
 - DocumentRoot
 - <http://httpd.apache.org/docs/2.2/vhosts>

```
Listen 80
Listen 8080

NameVirtualHost 172.20.30.40:80
NameVirtualHost 172.20.30.40:8080
<VirtualHost 172.20.30.40:80>
    ServerName www.example.com
    DocumentRoot /www/domain-80
</VirtualHost>
<VirtualHost 172.20.30.40:8080>
    ServerName www.example.com
    DocumentRoot /www/domain-8080
</VirtualHost>
<VirtualHost 172.20.30.40:80>
    ServerName www.example.org
    DocumentRoot /www/otherdomain-80
</VirtualHost>
<VirtualHost 172.20.30.40:8080>
    ServerName www.example.org
    DocumentRoot /www/otherdomain-8080
</VirtualHost>
```

Supplemental configuration – More...

- Multi-language error messages
 - `httpd-multilang-errordoc.conf`
- Fancy directory listings
 - `httpd-autoindex.conf`
- Language settings
 - `httpd-languages.conf`
- Real-time info on requests and configuration
 - `httpd-info.conf`
- Local access to the Apache HTTP Server Manual
 - `httpd-manual.conf`
- Various default settings
 - `httpd-default.conf`

Other configuration for Apache – log

- Rotate your log using newsyslog
- In httpd config
 - ErrorLog "/var/log/httpd-error.log"
 - TransferLog "/var/log/httpd-access.log"

```
/var/log/httpd-access.log    640  5  *  @T00  z  /var/run/httpd.pid
/var/log/httpd-error.log    640  5  *  @T00  z  /var/run/httpd.pid
```

- In startup script
 - _pidprefix="/var/run/httpd"
 - pidfile="\${_pidprefix}.pid"

.htaccess (1)

- .htaccess
 - Allow admin or users to control access to certain directory
- Usage
 - Modify httpd.conf
 - Create .htaccess file
 - Generate password database
 - Test

.htaccess (2)

- Example
 - Modify httpd.conf
 - Create .htaccess file
 - Generate password file

```
<Directory "/home/wwwadm/data/test1">  
    Options None  
    AllowOverride All  
    Order allow,deny  
    Allow from all  
</Directory>
```

```
$ cat .htaccess  
AuthName "SA-test1"  
AuthType "Basic"  
AuthUserFile "/home/wwwadm/data/test1/.htpasswd"  
Require valid-user  
Options Indexes
```

```
$ htpasswd -c ./htpasswd SA-user1  
New password:  
Re-type new password:  
Adding password for user SA-user1
```

.htaccess (3)

- You can use these tools to generate .htaccess
 - <http://www.linuxkungfu.org/tools/htaccesser/index.php>
 - <http://www.htaccesseditor.com/>



Installing PHP7 (1)

- Steps

- `$ pkg install php74 php74-mysqli mod_php74 php74-zlib \ php74-mbstring php74-gd php74-json php74-curl`
- `$ vim /usr/local/etc/apache24/Includes/php.conf`

```
<IfModule dir_module>
  DirectoryIndex index.php index.html
  <FilesMatch "\.php$" >
    SetHandler application/x-httpd-php
  </FilesMatch>
  <FilesMatch "\.phps$" >
    SetHandler application/x-httpd-php-source
  </FilesMatch>
</IfModule>
```

Test PHP7 in apache (2)

- Start apache
 - \$ /usr/local/etc/rc.d/apache24 start
 - \$ service apache24 restart
- Test PHP
 - \$ vim /usr/local/www/apache24/data/index.php

```
<?  
    phpinfo();  
?>
```

phpinfo()

PHP Version 7.1.10

System	FreeBSD tbsdweicc 11.1-RELEASE FreeBSD 11.1-RELEASE #0 r321309: Fri Jul 21 02:08:28 UTC 2017 root@releng2.nyi.freebsd.org:/usr/obj/usr/src/sys/GENERIC amd64
Build Date	Nov 17 2017 07:06:25
Configure Command	'./configure' '--with-layout=GNU' '--localstatedir=/var' '--with-config-file-scan-dir=/usr/local/etc/php' '--disable-all' '--enable-libxml' '--enable-mysqlnd' '--with-libxml-dir=/usr/local' '--with-pcre-regex=/usr/local' '--program-prefix=' '--disable-cli' '--disable-cgi' '--with-apxs2=/usr/local/sbin/apxs' '--enable-dtrace' '--prefix=/usr/local' '--mandir=/usr/local/man' '--infodir=/usr/local/info' '--build=amd64-portbld-freebsd11.0' 'build_alias=amd64-portbld-freebsd11.0' 'CFLAGS=-O2 -pipe -fstack-protector -fno-strict-aliasing' 'CPPFLAGS=' 'CPP=cpp'
Server API	Apache 2.0 Handler
Virtual Directory Support	disabled
Configuration File (php.ini) Path	/usr/local/etc
Loaded Configuration File	(none)
Scan this dir for additional .ini files	/usr/local/etc/php
Additional .ini files parsed	/usr/local/etc/php/ext-20-curl.ini, /usr/local/etc/php/ext-20-gd.ini, /usr/local/etc/php/ext-20-json.ini, /usr/local/etc/php/ext-20-mbstring.ini, /usr/local/etc/php/ext-20-mcrypt.ini, /usr/local/etc/php/ext-20-mysqli.ini, /usr/local/etc/php/ext-20-zlib.ini
PHP API	20160303
PHP Extension	20160303
Zend Extension	320160303
Zend Extension Build	API320160303,NTS
PHP Extension Build	API20160303,NTS
Debug Build	no
Thread Safety	disabled
Zend Signal Handling	enabled
Zend Memory Manager	enabled
Zend Multibyte Support	provided by mbstring
IPv6 Support	enabled
DTrace Support	available, disabled
Registered PHP Streams	php, file, glob, data, http, ftp, compress.zlib
Registered Stream Socket Transports	tcp, udp, unix, udg
Registered Stream Filters	string.rot13, string.toupper, string.tolower, string.strip_tags, convert.*, consumed, dechunk, mcrypt.*, mdecrypt.*, zlib.*

This program makes use of the Zend Scripting Language Engine:
 Zend Engine v3.1.0, Copyright (c) 1998-2017 Zend Technologies



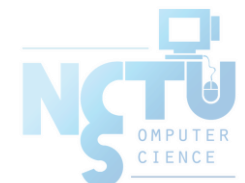

Architecture

Cluster, Server Load Balancer

陽明交大資工系資訊中心

Information Technology Center of Department of Computer Science, NYCU

Load balance

- Nginx proxy

```
upstream backend {  
    server 172.16.1.1:3000;  
    server 172.16.1.2:3000;  
}  
server {  
    listen 80;  
    server_name www.example.com;  
    location / {  
        proxy_pass  
        http://backend;  
    }  
}
```

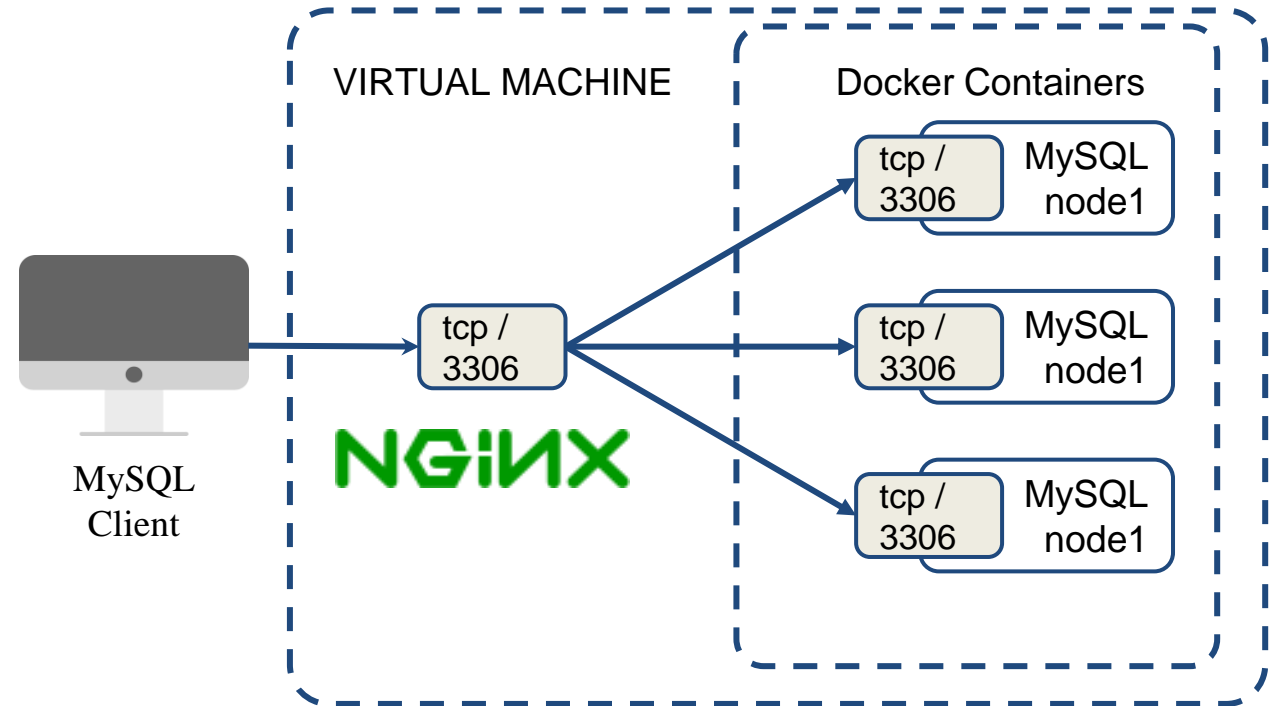

Load balance

- Open Source
 - haproxy - <http://www.haproxy.org/>
 - envoy - <https://www.envoyproxy.io/>
- Commercial
 - F5
 - A10
 - AWS ELB
 - Google Cloud Load Balance

MySQL cluster

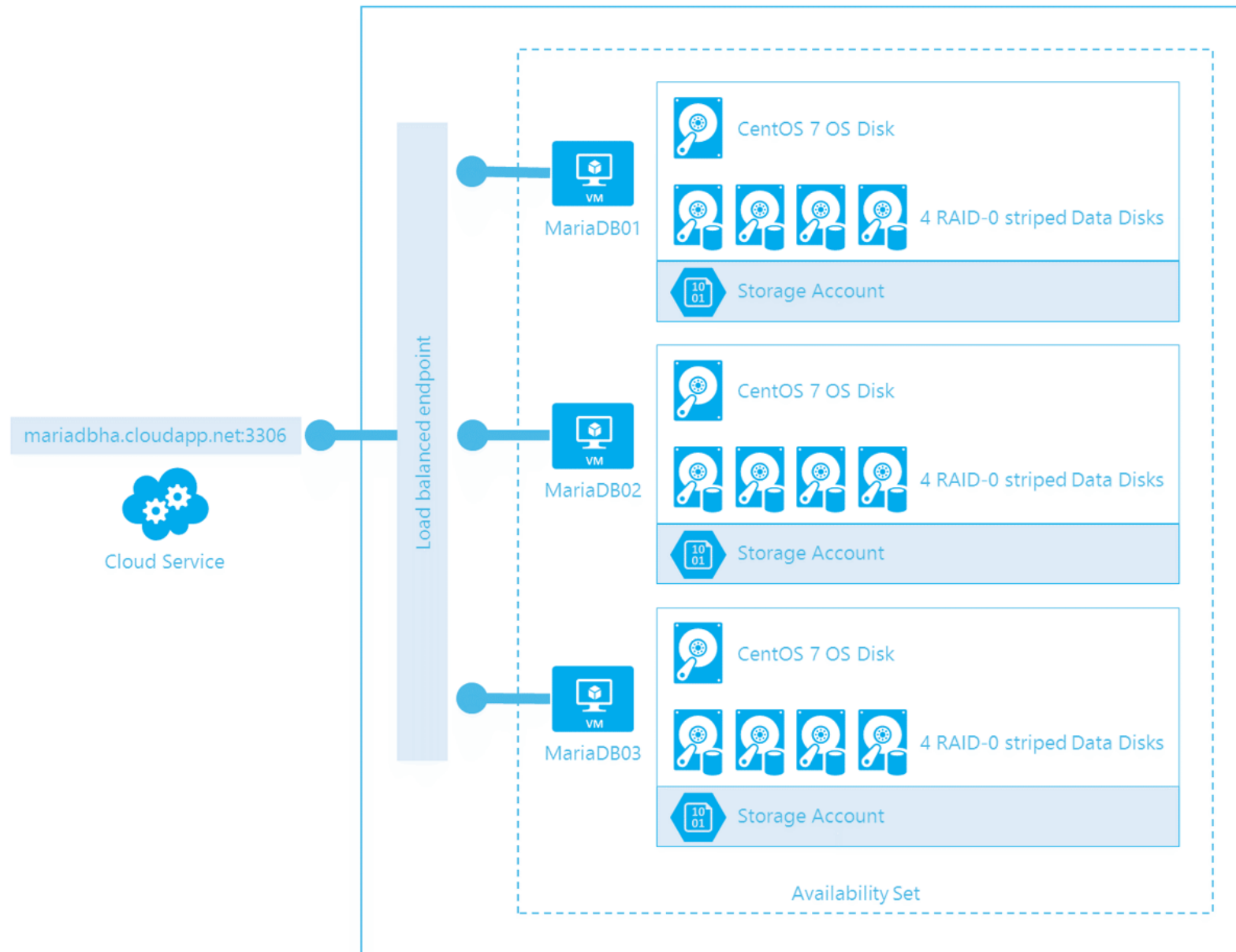

Up to 150 users

- One machine running the application server.
 - Web server
 - database server
 - local storage
- Authentication via an existing LDAP or Active Directory server.

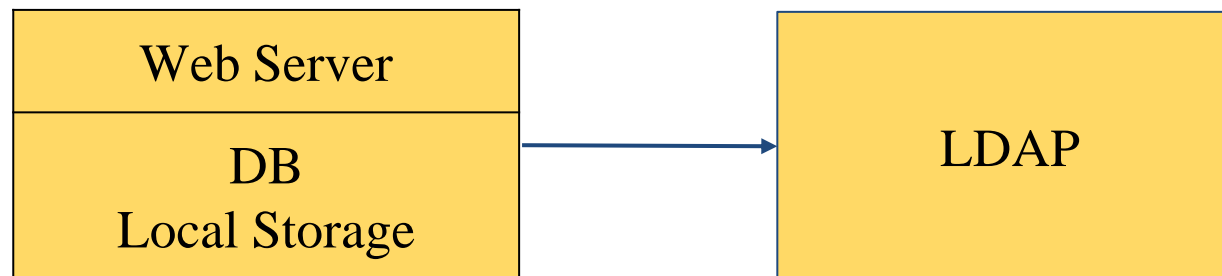

150 to 1,000 users

- High availability level
 - Every component is fully redundant and can fail without service interruption.
 - Backups without service interruption

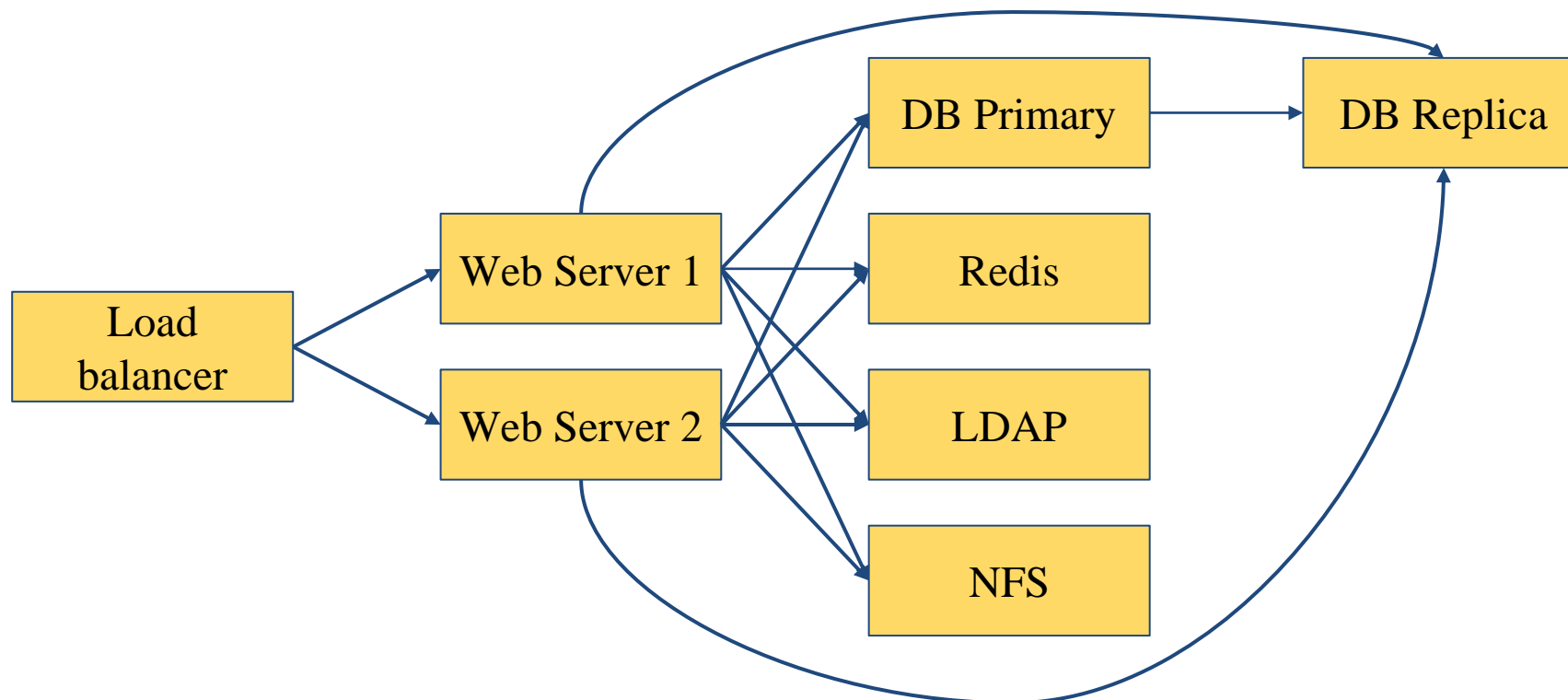

5,000 to >100,000 users

- 4 to 20 application/Web servers.
- A cluster of two or more database servers
 - behind a load balancer to send all writes to the master and reads to the slaves.
- Storage is an NFS server, or an object store that is S3 compatible.

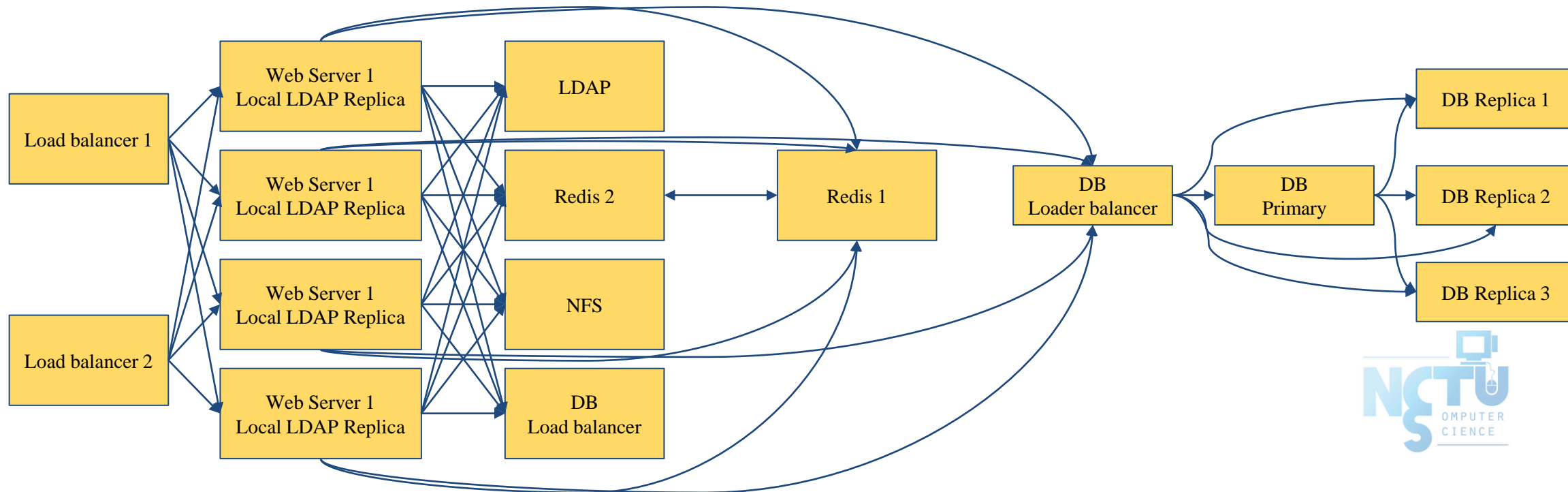

Appendix

phpMyAdmin / lighttpd / FastCGI

陽明交大資工系資訊中心

Information Technology Center of Department of Computer Science, NYCU

phpMyAdmin

- phpMyAdmin can manage a whole MySQL server as well as a single database over the World Wide Web.
- Official Site: <http://www.phpmyadmin.net/>
- Documentation: <http://www.phpmyadmin.net/documentation/>
- Features
 - Browser-based, Supporting PHP5.3+, MySQL 5.0+, Open Source
- There are four authentication modes offered:
 - http
 - cookie
 - signon
 - config (the less secure one, not recommended).

Installing phpMyAdmin (1)

- databases/phpmyadmin
 - \$ make install clean
- Installed...

```
phpMyAdmin-4.7.4 has been installed into:
  /usr/local/www/phpMyAdmin

Please edit config.inc.php to suit your needs.

To make phpMyAdmin available through your web site, I suggest
that you add something like the following to httpd.conf:

Alias /phpmyadmin/ "/usr/local/www/phpMyAdmin/"

<Directory "/usr/local/www/phpMyAdmin/">
  Options none
  AllowOverride Limit

  Order Deny,Allow
  Deny from all
  Allow from 127.0.0.1 .example.com
</Directory>
```

Installing phpMyAdmin (2)

- config.inc.php
 - Override libraries/config.default.php
- config.sample.inc.php
 - `$cfg['blowfish_secret']`

Administering MySQL – Using phpMyAdmin (3)



歡迎使用 phpMyAdmin

語系 - *Language*

中文 - Chinese traditional

登入 

使用者名稱:

密碼:

執行

Administering MySQL – Using phpMyAdmin (4)

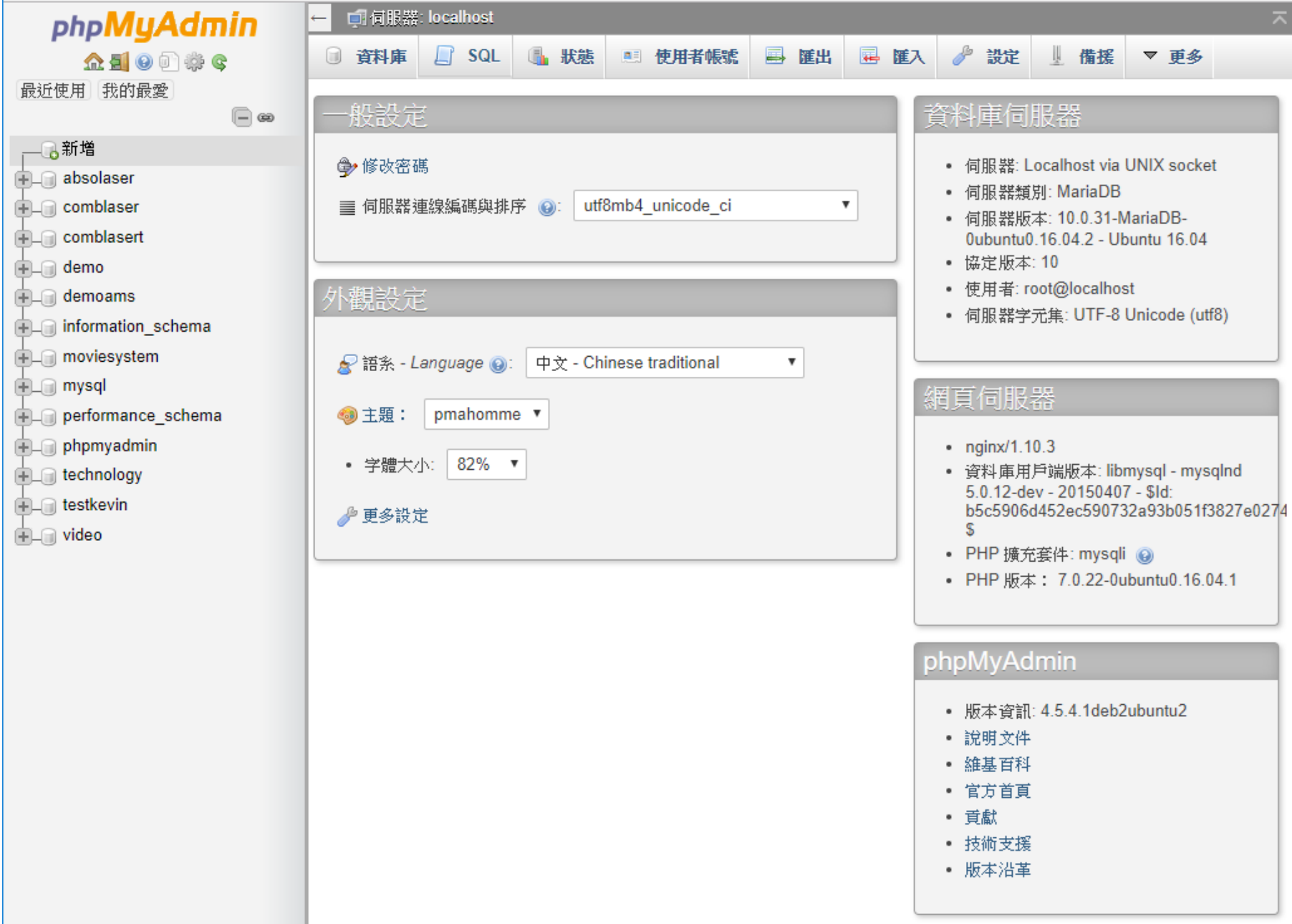

The screenshot displays the phpMyAdmin web interface for a MySQL server on localhost. The interface is in Chinese and shows various configuration panels:

- 一般設定 (General):** Includes options for "修改密碼" (Change Password) and "伺服器連線編碼與排序" (Server Connection Character Set and Collation), which is currently set to "utf8mb4_unicode_ci".
- 外觀設定 (Appearance):** Includes options for "語系 - Language" (Language) set to "中文 - Chinese traditional", "主題" (Theme) set to "pmahomme", and "字體大小" (Font Size) set to "82%".
- 資料庫伺服器 (Database Server):** Lists server details: "伺服器: Localhost via UNIX socket", "伺服器類別: MariaDB", "伺服器版本: 10.0.31-MariaDB-0ubuntu0.16.04.2 - Ubuntu 16.04", "協定版本: 10", "使用者: root@localhost", and "伺服器字元集: UTF-8 Unicode (utf8)".
- 網頁伺服器 (Web Server):** Lists web server details: "nginx/1.10.3", "資料庫用戶端版本: libmysql - mysqlnd 5.0.12-dev - 20150407 - \$Id: b5c5906d452ec590732a93b051f3827e0274\$ ", "PHP 擴充套件: mysqli", and "PHP 版本: 7.0.22-0ubuntu0.16.04.1".
- phpMyAdmin:** Lists version and resource information: "版本資訊: 4.5.4.1deb2ubuntu2", "說明文件", "維基百科", "官方首頁", "貢獻", "技術支援", and "版本沿革".

The left sidebar shows a list of databases and users, including "absolaser", "comblaser", "comblasert", "demo", "demoams", "information_schema", "moviesystem", "mysql", "performance_schema", "phpmyadmin", "technology", "testkevin", and "video".

Administering MySQL – Using phpMyAdmin (5)

- Create another user with limited privilege

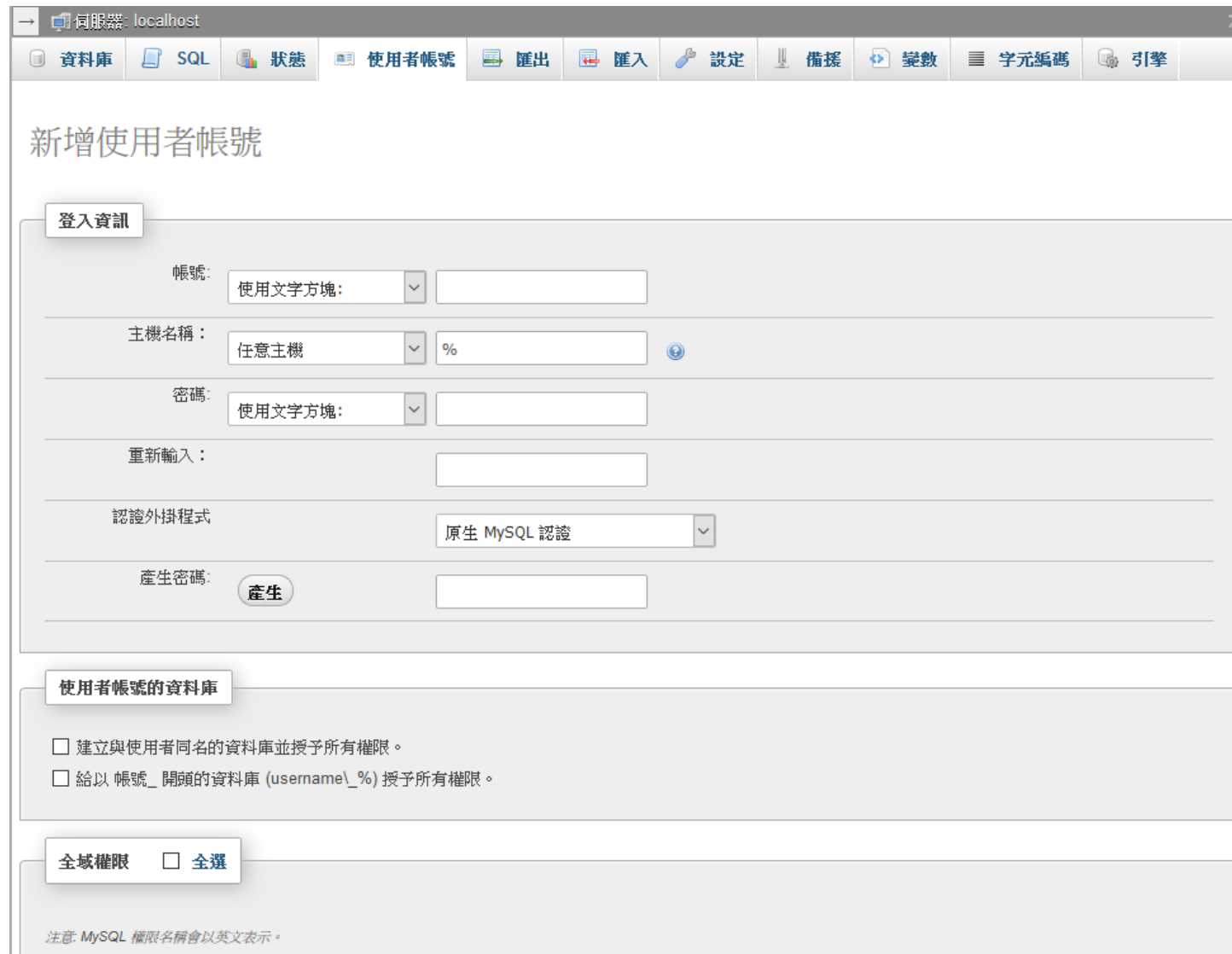

The screenshot shows the 'Add User' (新增使用者帳號) form in phpMyAdmin. The browser address bar shows 'localhost'. The navigation menu includes '資料庫', 'SQL', '狀態', '使用者帳號', '匯出', '匯入', '設定', '備援', '變數', '字元編碼', and '引擎'. The form is divided into three sections:

- 登入資訊 (Login Information):** Fields for '帳號' (Username) and '密碼' (Password) with '使用文字方塊' (Use text box) dropdowns. '主機名稱' (Host name) is set to '任意主機' (Any host) with a '%' wildcard. '重新輸入' (Re-enter) is a required field. '認證外掛程式' (Authentication plugin) is set to '原生 MySQL 認證' (Native MySQL authentication). A '產生密碼' (Generate password) button is present.
- 使用者帳號的資料庫 (Database for user):** Two checkboxes: '建立與使用者同名的資料庫並授予所有權限。' (Create a database with the same name as the user and grant all privileges) and '給以 帳號_ 開頭的資料庫 (username_%) 授予所有權限。' (Grant all privileges to a database starting with the username_%).
- 全域權限 (Global privileges):** A checkbox for '全選' (All).

注意: MySQL 權限名稱會以英文表示。

PopSQL & SQLpro (1)

The screenshot shows the PopSQL web interface. At the top, there's a window title 'dellstore' and a 'Feedback' link. The main heading is 'Weekly orders'. Below it are 'Run' and 'Share' buttons. The SQL query is as follows:

```
1 select
2     date_trunc('week', orderdate) as week,
3     count(1)
4 from orders
5 where orderdate between '2004-01-01' and '2004-02-28'
6 group by 1
7 order by 1
8 limit 5
```

The results are displayed in two panels. The top panel is a line chart showing the count of orders per week. The bottom panel is a table with the same data.

Success 9:51 AM
5 rows 0.146 seconds

Explore SQL Data Chart Export %

week	count
2003-12-29 00:00:00-08	125
2004-01-05 00:00:00-08	238
2004-01-12 00:00:00-08	225
2004-01-19 00:00:00-08	210
2004-01-26 00:00:00-08	241

Success 9:50 AM
5 rows 0.145 seconds

Explore SQL Data Chart Export %

week	count
2003-12-29 00:00:00-08	125
2004-01-05 00:00:00-08	238
2004-01-12 00:00:00-08	225
2004-01-19 00:00:00-08	210
2004-01-26 00:00:00-08	241

PopSQL & SQLpro (2)

The screenshot shows the SQLPro for Postgres application interface. The main window displays a query execution window with the following SQL code:

```
1 SELECT * FROM nicer_but_slower_film_list LIMIT 100;  
2 select * from city
```

The interface shows a table of results with the following columns: fid, title, description, category, price, length, rating, and a column for actor information. The table contains 20 rows of data.

fid	title	description	category	price	length	rating	actor
1	Academy Dinosaur	A Epic Drama of a Feminist And a Mad Scientist...	Documentary	0.99	86	PG	RockD
2	Ace Goldfinger	A Astounding Epistle of a Database Administrato...	Horror	4.99	48	G	Minnie
3	Adaptation Holes	A Astounding Reflection of a Lumberjack And a ...	Documentary	2.99	50	NC-17	Camer
4	Affair Prejudice	A Fanciful Documentary of a Frisbee And a Lumb...	Horror	2.99	117	G	JodieD
5	African Egg	A Fast-Paced Documentary of a Pastry Chef And...	Family	2.99	130	G	Dustin
6	Agent Truman	A Intrepid Panorama of a Robot And a Boy who...	Foreign	2.99	169	PG	Warren
7	Airplane Sierra	A Touching Saga of a Hunter And a Butler who m...	Comedy	4.99	62	PG-13	Menah
8	Airport Pollock	A Epic Tale of a Moose And a Girl who must Con...	Horror	4.99	54	R	Lucille
9	An Alabama Devil	A Thoughtful Panorama of a Database Administr...	Horror	2.99	114	PG-13	William
10	Aladdin Calendar	A Action-Packed Tale of a Man And a Lumberjac...	Sports	4.99	63	NC-17	GretaM
11	Alamo Videotape	A Boring Epistle of a Butler And a Cat who must...	Foreign	0.99	126	G	Michael
12	Alaska Phantom	A Fanciful Saga of a Hunter And a Pastry Chef w...	Music	0.99	136	PG	ValBol
13	Ali Forever	A Action-Packed Drama of a Dentist And a Croc...	Horror	4.99	150	PG	Christo
14	Alice Fantasia	A Emotional Drama of a A Shark And a Database...	Classics	0.99	94	NC-17	Woody
15	Alien Center	A Brilliant Drama of a Cat And a Mad Scientist w...	Foreign	2.99	46	NC-17	Sidney
16	Alley Evolution	A Fast-Paced Drama of a Robot And a Compose...	Foreign	2.99	180	NC-17	Gregor
17	Alone Trip	A Fast-Paced Character Study of a Composer A...	Music	0.99	82	R	Reneel
18	Alter Victory	A Thoughtful Drama of a Composer And a Femin...	Animation	0.99	57	PG-13	JadaRy
19	Amadeus Holy	A Emotional Display of a Pioneer And a Technical...	Action	0.99	113	PG	Penelo
20	Amelie Hellfighters	A Boring Drama of a Woman And a Squirrel who...	Music	4.99	79	R	LauraE

Finished with 100 records. 0.217 seconds.

Installing lighttpd

- `www/lighttpd`
 - Official: <http://www.lighttpd.net/>
- Configuration files
 - `/usr/local/etc/lighttpd/{lighttpd,modules}.conf`
 - `/usr/local/etc/lighttpd/{vhosts,conf}.d/`
- Startup script
 - `/usr/local/etc/rc.d/lighttpd`
- Documentation:
 - `/usr/ports/www/lighttpd/work/lighttpd-1.4.28/doc/*.txt`
 - `alias, cgi, dirlisting, fastcgi, ssl, userdir`
 - Virtual hosts: `evhost, mysqlvhost, simple-vhost`

FastCGI

- FastCGI is actually CGI with only a few extensions.
 - FastCGI is language-independent.
 - FastCGI run applications in processes isolated from the core Web server, which provides greater security than APIs.
 - FastCGI developers are committed to propagating FastCGI as an open standard. (C/C++, Java, Perl, Tcl)
 - FastCGI is not tied to the internal architecture of any Web server and is therefore stable even when server technology changes.
- Benefits:
 - Distributed computing
 - Multiple and extensible roles
- Official site: <http://www.fastcgi.com/drupal/>